

1.0 8V 4C - KA / FIESTA 1.0 8V : 96/99 - MTR OHV ENDURA

| | | | |
|-------------|---|------------|------------------------------------|
| 11208-JGCB | JG JTA MTR S/ CAB | 11208-JGRS | JG RETIF MTR S/ CAB |
| 11208-JGSC | JG JTA MTR C/ CAB DE FIBRA | 11208-JGRV | JG RETIF MTR C/ CAB DE FIBRA |
| 11208-JRSC | JG JTA MTR C/ CAB DE FIBRA E C/ RET | 11208-JRRV | JG RETIF MTR C/ CAB DE FIBRA E RET |
| 11208-JGSAL | JG JTA MTR C/ CAB DE FIBRA (CRT ALUMÍNIO) | | |
| 11208-JRSAL | JG JTA MTR C/ CAB DE FIBRA E C/ RET(CRT AL) | | |

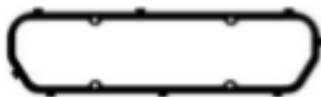

11201 SC - 1,6 MM - CIL. 70 MM
11201 KT - 2,6 MM - CIL. 70 MM
JTA CABEÇOTE



11126 CB
JTA TAMPAS VALVULAS



11221 PAK
JTA ADMISSÃO
Nº ORIG: 95BM9441AC



11141 NA
JTA ADMISSÃO
Nº ORIG: 98BM9441AA

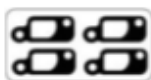

37 PAK
JTA COLETOR ESCAPE
Nº ORIG: 95BM9448AC



11125 NA
JTA DA BOMBA DA
AGUA
Nº ORIG: 6189107



11132 NA
JTA VALV.
TERMOSTÁTICA



11167 PAK
JTA DO ESCAPE



11127 PAK
JTA DO ESCAPE

JG JTA RETIFICAÇÃO



11208 KTBO
KIT VEDADORES DO MOTOR



11130 NA
JTA DISTRIBUIÇÃO TRAS.
Nº ORIG: 89BM6344BA



11146 NA
JTA BBA ÓLEO



OR1-130
ANEL ORING
40,94 X 2,62 MM



261420
ANEL BUJÃO CARTER



OR1-121
ANEL ORING
26,64 X 2,62 MM



11129 NA
JTA DISTRIBUIÇÃO



11216 BI
JTA DO CARTER
Nº ORIG: (CARTER ALUMÍNIO)



11216 CB
JTA CARTER
Nº ORIG: 850X6013A2A

11208-KP KIT PARAFUSOS DO CABEÇOTE

11208-KTRT KIT DE RETENORES DO MOTOR RET VALVULAS-07X11X10,5



1212919

RET. DIANT GIRABREQUIM - RET. GIRABREQUIM TRASEIRO 36,5X52,48X08 79X95,25X11,11



1135167



1135166

1.0/1.3 8V - FORD - ESCORT / DEL REY: 1.3 83/ - HOBBY 1.0 94/96 - MTR CHT 1.3

1.0/1.3 8V - VW - GOL 1000 AE 93/96 - MTR CHT 1.3

| | | | |
|------------|-------------------------------------|------------|------------------------------------|
| 11806-JGCB | JG JTA MTR S/ CAB | 11806-JGRS | JG RETIF MTR S/ CAB |
| 11806-JGSC | JG JTA MTR C/ CAB DE FIBRA | 11806-JGRV | JG RETIF MTR C/ CAB DE FIBRA |
| 11806-JRSC | JG JTA MTR C/ CAB DE FIBRA E C/ RET | 11806-JRRV | JG RETIF MTR C/ CAB DE FIBRA E RET |

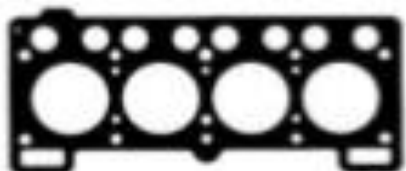

11801 SC - 1,4 MM - CIL. 73 MM
11801 KT - 2,4 MM - CIL. 73 MM
11801 TB - 1,9 MM - CIL. 73 MM
 JTA CABEÇOTE
 Nº ORIG: 84AV6051B



11226 BO
 JTA TAMPA VÁLVULAS
 Nº ORIG: BDIM6584



11821 PAK
11821 CC
 JTA COLETOR ESCAPE
 Nº ORIG: 84AV9448A



11635 BC
 JG BORRACHAS



11030 NA
 JTA
 PEQUENA
 ADMISSÃO



11822 PAK
 JUNTA DE



46024 PAK
46024 FF
 JTA DO ESCAPE



11830 NA
 JTA TRAS.
 CABEÇOTE
 Nº ORIG:
 84AV6W021A



11831 NA
 JTA BBA
 DAGUA
 Nº ORIG:
 84AV8507A



11655 NA
 JTA BBA D AGUA
 Nº
 ORIG:84AV8507AA

JG JTA RETIFICAÇÃO



11832 NA
 JTA BBA
 AGUA
 Nº ORIG:
 84AV8513A



11032 NA
 JTA VÁLVULA
 TERMOSTÁTICA
 Nº ORIG:
 0291211392



11272 NA
 JTA BBA
 COMBUSTIVEL
 Nº ORIG:



11632 CB
 JTA BOAL
 ÓLEO
 Nº ORIG:



11636 GV
 JTA BBA
 ÓLEO
 Nº ORIG:



11833 GV
 JTA
 DISTRIBUI
 DOR
 Nº ORIG:
 6071557



261420
 ANEL BUJÃO CARTER
 Nº ORIG: D7FZ6734A



11625 FL
 JTA CAMISA
 Nº ORIG: BD9M6C055A



11228 PV
11228 CB
 JTA DA DISTRIBUIÇÃO
 Nº ORIG: 73MU6020A



11816 CB
 JG JTA CARTER
 Nº ORIG: 845U6781A

11807-KP
KIT PARAFUSOS DO CABEÇOTE

11807-KTRT
KIT DE RETENORES DO MOTOR
RET VÁLVULAS-07X11X10,5



1121919

RET. DIANT GIRABREQUIM - RET. GIRABREQUIM TRASEIRO

35X50X08

82X105X12



1112456



1111945

1.0 8V 4C - KA 97/ - FIESTA 99/ - MTR ZETEC ROCAN

| | | | |
|------------|-------------------------------------|------------|------------------------------------|
| 11004-JGCB | JG JTA MTR S/ CAB | 11004-JGRS | JG RETIF MTR S/ CAB |
| 11004-JGSC | JG JTA MTR C/ CAB DE FIBRA | 11004-JGRV | JG RETIF MTR C/ CAB DE FIBRA |
| 11004-JGML | JG JTA MTR C/ CAB DE CHAPA | 11004-JGRM | JG RETIF MTR C/ CAB DE CHAPA |
| 11004-JRSC | JG JTA MTR C/ CAB DE FIBRA E C/ RET | 11004-JRRV | JG RETIF MTR C/ CAB DE FIBRA E RET |
| 11004-JRML | JG JTA MTR C/ CAB DE CHAPA E C/ RET | 11004-JRRM | JG RETIF MTR C/ CAB DE CHAPA E RET |

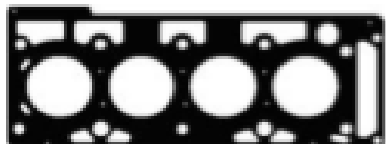

11001 SC - 1,2 MM - CIL. 70,5 MM
 11001 KT - 2,2 MM - CIL. 70,5 MM
 11001 MLS - 0,5 MM - CIL. 70,5 MM
 11001 MLS-2M - 1,5 MM - CIL. 70,5 MM



11121 JGBO
 JG JTA ADMISSÃO - Nº ORIG: XS6E9441AB

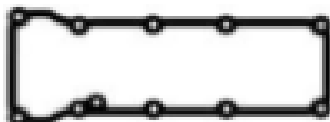

11626 BO
 JTA TAMPA VALVULAS
 Nº ORIG: XS6E8255AB



11122 OR
 11122 F
 JTA DO COLETOR DE ESCAPE
 Nº ORIG: XS6E9448AC



11425 PAK
 11425 F
 JTA ESCAPE
 Nº ORIG: XS619451DC



11843 BO
 JTA CARÇAÇA
 TERMOSTATO
 Nº ORIG:
 XS6E8255BC



11040 NA
 JTA SUPORTE BBA
 ÓLEO
 Nº ORIG:

JG JTA RETIFICAÇÃO



11429 NA
 JTA DISTRIBUIÇÃO



OR1-117
 ANEL ORING
 20,29 X 2,62



11087 BO
 ANEL TERMOSTATO
 Nº ORIG: W7032735300



11092 BO
 VEDADOR VÁLVULA DE DESVIO
 Nº ORIG: 958F9F670BB



11016 BI
 11016 BA
 JTA DO CARTER
 Nº ORIG: X56E6710A2B

11004-KP
 KIT PARAFUSOS DO CABEÇOTE

11004-KTRT 11004 KTRT-F (com ret flange tras.)
 KIT DE RETENORES DO MOTOR

RET VALVULAS-06X11X18,5



1212919

RET. DIANT GIRABREQUIM - FLANGE TRASEIRO
 40X62X7,5



1130045



11004 FR

1.0 8V 4C - FIESTA *SUPERCHARGER*

| | | | |
|------------|-------------------------------------|------------|------------------------------------|
| 11006-JGCB | JG JTA MTR S/ CAB | 11006-JGRS | JG RETIF MTR S/ CAB |
| 11006-JGSC | JG JTA MTR C/ CAB DE FIBRA | 11006-JGRV | JG RETIF MTR C/ CAB DE FIBRA |
| 11006-JGML | JG JTA MTR C/ CAB DE CHAPA | 11006-JGRM | JG RETIF MTR C/ CAB DE CHAPA |
| 11006-JRSC | JG JTA MTR C/ CAB DE FIBRA E C/ RET | 11006-JRRV | JG RETIF MTR C/ CAB DE FIBRA E RET |
| 11006-JRML | JG JTA MTR C/ CAB DE CHAPA E C/ RET | 11006-JRRM | JG RETIF MTR C/ CAB DE CHAPA E RET |

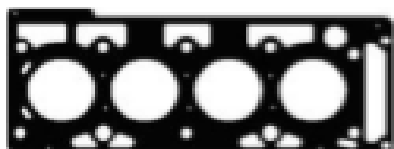

11001 SC - 1,2 MM - CIL. 70,5 MM
11001 KT - 2,2 MM - CIL. 70,5 MM
11001 MLS - 0,5 MM - CIL. 70,5 MM
11001 MLS-2M - 1,5 MM - CIL. 70,5 MM

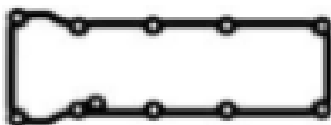

11626 BO
JTA TAMPA VALVULAS
Nº ORIG: XS6E8255AB



11425 OR
11425 F
JTA ESCAPE
Nº ORIG: XS619451DC

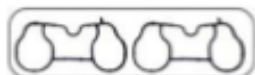

11120 JGBO
JG DE JUNTAS DA ADMISSÃO



11087 BO
ANEL
TERMOSTATO



11119 MLS
11119 PAK
JUNTA DO COLETOR DE ESCAPE
Nº ORIG: XS6E9448AC



11843 BO
JTA CARÇAÇA
TERMOSTATO
Nº ORIG:
XS6E8255BC



11040 NA
JTA SUPORTE BBA
ÓLEO
Nº ORIG:

JG JTA RETIFICAÇÃO



11429 NA
JTA DISTRIBUIÇÃO



OR1-117
ANEL ORING
20,29 X 2,62



11092 BO
VEDADOR VÁLVULA DE DESVIO
Nº ORIG: 958F9F670BB



11016 BI
11016 BA
JTA DO CARTER

11004-KP
KIT PARAFUSOS DO CABEÇOTE

11004-KTRT 11004 KTRT-F (com ret flange tras.)
KIT DE RETENORES DO MOTOR
RET VALVULAS-06X11X18,5



1212919

RET. DIANT GIRABREQUIM - FLANGE TRASEIRO

40X62X7,5



1130045



11004 FR

1.0 12V 3 C - KA / KA+ / NEW FIESTA - MOTOR ECOBOOSTER TIVCT / M2DA / M1DA

| | | | |
|------------|-------------------------------------|------------|------------------------------------|
| 12505-JGCB | JG JTA MTR S/ CAB | 12505-JGRS | JG RETIF MTR S/ CAB |
| 12505-JGSC | JG JTA MTR C/ CAB DE FIBRA | 12505-JGRV | JG RETIF MTR C/ CAB DE FIBRA |
| 12505-JGML | JG JTA MTR C/ CAB DE CHAPA | 12505-JGRM | JG RETIF MTR C/ CAB DE CHAPA |
| 12505-JRSC | JG JTA MTR C/ CAB DE FIBRA E C/ RET | 12505-JRRV | JG RETIF MTR C/ CAB DE FIBRA E RET |
| 12505-JRML | JG JTA MTR C/ CAB DE CHAPA E C/ RET | 12505-JRRM | JG RETIF MTR C/ CAB DE CHAPA E RET |



12502 SC - 1,2 MM - CIL. 73 MM
12502 MLS - 0,7 MM - CIL. 73 MM
JTA DO CABEÇOTE

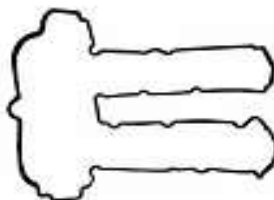

12527 BO
11527 SI



12523 MLS
12523 F



12519 JGBO
JTA ADMISSÃO



12533 BO
JUNTA TERMOSTATO



12578 BO
ANEL CORPO
BORBOLETA



12532 BO
JTA VÁLVULA
TERMOSTÁTICA



12524 MLS
12524 F
JUNTA DO
CATALIZADOR

12505 KTBO
KIT VEDADORES MOTOR

JG JTA RETIFICAÇÃO

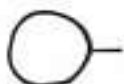

12531 BO
JTA ESPELHO



12530 NA
JTA ESPELHO

XXXXX-KP
KIT PARAFUSOS DO CABEÇOTE

12505-KTRT 12505 KTRT-F (com ret flange tras.)
KIT DE RETENTORES DO MOTOR

RET VALVULAS-4,25X09X17



1230090

FLANGE TRASEIRO



11300290

RET DIANT
55X70X085



1122656

1.3 8V 4C - CORCEL I 71/77

| | | | |
|------------|-------------------------------------|------------|------------------------------------|
| 11220-JGCB | JG JTA MTR S/ CAB | 11220-JGRS | JG RETIF MTR S/ CAB |
| 11220-JGSC | JG JTA MTR C/ CAB DE FIBRA | 11220-JGRV | JG RETIF MTR C/ CAB DE FIBRA |
| 11220-JRSC | JG JTA MTR C/ CAB DE FIBRA E C/ RET | 11220-JRRV | JG RETIF MTR C/ CAB DE FIBRA E RET |

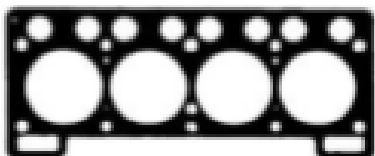

11601 SC - 1,4 MM - CIL. 77 MM
11601 KT - 2,4 MM - CIL. 77 MM
11601 TB - 1,9 MM - CIL. 77 MM
JTA CABEÇOTE
Nº ORIG: 928M6051BH



11621 PAK
JTA COLETOR ESCAPE
Nº ORIG: BD9M9654A

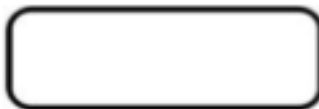

11226 BO
JTA TAMPA VÁLVULAS
Nº ORIG: BD1M6584



11635 BC
JG BORRACHAS TAMPA VÁLVULAS
Nº ORIG: 65583



11231 NA
JTA SUP. BBA



11237 PAK
JTA ESCAPE
Nº ORIG: BEOM9451A



11230 NA
JTA TPA
TRAS. CAB



10334 PAK
GAXETA ESCAPE

JG JTA RETIFICAÇÃO



11234 NA
JTA BBA
COMBÚSTIVEL



11235 NA
JTA BASE
CARB.



11236 GV
JTA BBA
OLEO



11253 NA
JTA BASE



11248 NA
JTA BBA
COMBÚSTIVEL



11272 NA
JTA BBA
COMBÚSTIVEL



L1446 PAK
JTA ENTRE
COLETOR



11632 BO
JTA BOCAL



11636 GV
JTA BBA OLEO



11228 NA
11228 CB
JTA DA DISTRIBUIÇÃO



11229 NA
JUNTA DA BOMBA
DA AGUA



11225 PP



11227 NA
JUNTA DA
BOMBA DE ÓI



11232 FA
1123 CI - ANEL DO
BUJÃO DO CARTER
18X24X1,5



11219 CB

XXXXX-KP KIT PARAFUSOS DO CABEÇOTE

11220-KTRT KIT DE RETENORES DO MOTOR

RET. DIANT GIRABREQUIM - RET. GIRABREQUIM TRASEIRO
35X50X08



1112456

70X90X10



1111135

1.3 8V 4C - KA / FIESTA : 95/ - COURIER 96/ : - MTR ENDURA OHV(HCS)

| | | | |
|-------------|---|------------|------------------------------|
| 11209-JGCB | JG JTA MTR S/ CAB | 11209-JGRS | JG RETIF MTR S/ CAB |
| 11209-JGSC | JG JTA MTR C/ CAB DE FIBRA | 11209-JGRV | JG RETIF MTR C/ CAB DE FIBRA |
| 11209-JGML | JG JTA MTR C/ CAB DE CHAPA | 11209-JGRM | JG RETIF MTR C/ CAB DE CHAPA |
| 11209-JGSAL | JG JTA MTR C/ CAB DE FIBRA (CRT ALUMÍNIO) | | |
| 11209-JRSAL | JG JTA MTR C/ CAB DE FIBRA E C/ RET(CRT AL) | | |

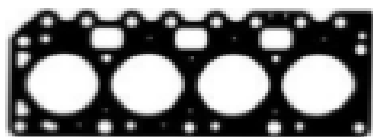

11202 SC - 1,6 MM - CIL. 75,5 MM
11202 KT - 2,6 MM - CIL. 75,5 MM
JTA CABEÇOTE
Nº ORIG: 96BM6051A2A

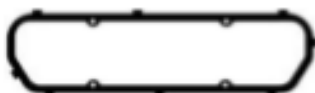

11126 CB
JTA TAMPA VALVULAS



11221 PAK
JTA ADMISSÃO
Nº ORIG: 95BM9441AC



11141 NA
JTA ADMISSÃO
Nº ORIG: 98BM9441AA

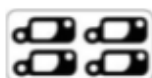

11137 PAK
JUNTA DO
COLETOR DE
ESCAPE



11167 PAK
JTA DO
ESCAPE



11132 NA
JTA VALV.
TERMOSTÁTICA



11125 NA
JTA DA BOMBA
DA AGUA



11127 PAK
JTA ESCAPE
NºORIG: 97KB9451AA

JG JTA RETIFICAÇÃO



11208 KTBO
KIT VEDADORES DO MOTOR



11130 NA
JTA DISTRIBUIÇÃO TRAS.
Nº ORIG: 89BM6344BA



11146 NA
JTA BBA ÓLEO



OR1-130
ANEL ORING
40,94 X 2,62 MM



261420
ANEL BUJÃO CARTER



OR1-121
ANEL ORING
26,64 X 2,62 MM



11129 NA
JTA DISTRIBUIÇÃO



11216 BI
JTA CARTER
Nº ORIG: (CARTER ALUMÍNIO)



11216 CB
JTA CARTER
Nº ORIG: 850X6013A2A

11208-KP KIT PARAFUSOS DO CABEÇOTE

11208-KTRT KIT DE RETENORES DO MOTOR RET VALVULAS-07X11X10,5



1212919

RET. DIANT GIRABREQUIM - RET. GIRABREQUIM TRASEIRO 36,5X52,48X08 79X95,25X11,11



1135167



1135166

1.4/1.6 8V 4C - CORCEL II 78/83

11620-JGCB JG JTA MTR S/ CAB

11620-JGRS JG RETIF MTR S/ CAB

11620-JGSC JG JTA MTR C/ CAB DE FIBRA

11620-JGRV JG RETIF MTR C/ CAB DE FIBRA

11620-JRSC JG JTA MTR C/ CAB DE FIBRA E C/ RET

11620-JRRV JG RETIF MTR C/ CAB DE FIBRA E RET

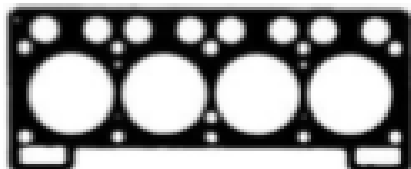

11601 SC - 1,4 MM - CIL. 77 MM
 11601 KT - 2,4 MM - CIL. 77 MM
 11601 TB - 1,9 MM - CIL. 77 MM
 JTA CABEÇOTE
 Nº ORIG: 928M6051BH



11226 BO
 JTA TAMPA VÁLVULAS
 Nº ORIG: BD1M6584



11635 BC
 JG BORRACHAS TAMPA VÁLVULAS
 Nº ORIG: 65583



11621 PAK
 JTA COLETOR ESCAPE
 Nº ORIG: BD9M9654A



11237 PAK
 JTA ESCAPE
 Nº ORIG: BEOM9451A



11230 NA
 JTA TPA
 TRAS. CAB



11231 NA
 JTA SUP. BBA



11631 CB
 JTA ISOLADORA FILTRO
 AR
 Nº ORIG: BD9M9654A

JG JTA RETIFICAÇÃO



11234 NA
 JTA BBA
 COMBÚSTIVEL



11235 NA
 JTA BASE
 CARB.



11236 GV
 JTA BBA
 OLEO



11253 NA
 JTA BASE



11248 NA
 JTA BBA
 COMBÚSTIVEL



11272 NA
 JTA BBA



11446 PAK
 JTA ENTRE



11632 BO
 JTA BOCAL
 ÓLEO



11636 GV
 JTA BBA OLEO



11228 NA
 11228 CB



11229 NA
 JUNTA DA
 BOMBA DA



11227 NA
 JTA BBA
 ÓLEO



261420
 ANEL BUJÃO
 CARTER



11625 FL



11816 CB

XXXXX-KP

KIT PARAFUSOS DO CABEÇOTE

11620-KTRT

KIT DE RETENORES DO MOTOR

RET. DIANT GIRABREQUIM - RET. GIRABREQUIM TRASEIRO

35X50X08

82X105X12



1112456



1111945

1.4 16V 4C - KA / FIESTA / COURIER : 96/ - MTR ZETEC SE - GAS

| | | | |
|------------|-------------------------------------|------------|------------------------------------|
| 11803-JGCB | JG JTA MTR S/ CAB | 11803-JGRS | JG RETIF MTR S/ CAB |
| 11803-JGSC | JG JTA MTR C/ CAB DE FIBRA | 11803-JGRV | JG RETIF MTR C/ CAB DE FIBRA |
| 11803-JGML | JG JTA MTR C/ CAB DE CHAPA | 11803-JGRM | JG RETIF MTR C/ CAB DE CHAPA |
| 11803-JRSC | JG JTA MTR C/ CAB DE FIBRA E C/ RET | 11803-JRRV | JG RETIF MTR C/ CAB DE FIBRA E RET |
| 11803-JRML | JG JTA MTR C/ CAB DE CHAPA E C/ RET | 11803-JRRM | JG RETIF MTR C/ CAB DE CHAPA E RET |

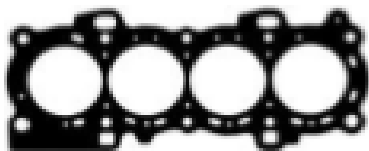

11401 SC - 1,4 MM - CIL. 78 MM
11401 MLS - - CIL. 78 MM
11401 KT - 2,4 MM - CIL. 78 MM
JTA CABEÇOTE
Nº ORIG: 97MM6051CC



11826 BO
JTA TAMPÁ VÁLVULAS
Nº ORIG: 98MM6M293A



11521 F
JTA COLETOR ESCAPE
Nº ORIG: 96MM9448AB



11420 JGBO
JG JTA ADMISSÃO
Nº ORIG: 96MM9441AD



46151 BO
VEDADOR 51,15 X43,85 X6,1 MM
NºORIG: 036129717E



11094 BO
VEDADOR ARANHA



11431 NA
JTA BBA D AGUA
Nº ORIG:

JG JTA RETIFICAÇÃO



11097 BO
VEDADOR INJEÇÃO
ELETRÔNICA



261420
ANEL BUJÃO CARTER



OR1-213
ANEL ORING
22,99 X 3,53 MM



OR1-121
ANEL ORING
26 X 2,5 MM



11528 NA
JTA
DISTRIBUIÇÃO
Nº ORIG:



11529 NA
JTA BBA AGUA
Nº ORIG:
98MM8507CC

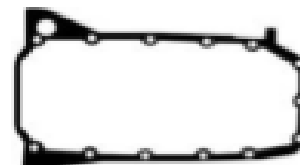

11516 BA
11516 CBLT
11516 NA
JTA CARTER

11803-KP KIT PARAFUSOS DO CABEÇOTE

11803-KTRT OU 11803 KTRT-F (com ret flange tras.) KIT DE RETENORES DO MOTOR

RET VALV-06X11X16,5



1230043

RETENTOR DIANT GIRABREQUIM

33X47X05



1130143

RET COMANDO-38X52X07



1130043

FLANGE TRASEIRO



11803 FR

1.6 8V 4C - ESCORT / BELINA / DEL REY / PAMPA / SCALA : 83/ - MTR CHT - GAS

1.6 8V 4C - GOL / VERONA : 93/ - MTR AE

11807-JGCB JG JTA MTR S/ CAB

11807-JGRS JG RETIF MTR S/ CAB

11807-JGSC JG JTA MTR C/ CAB DE FIBRA

11807-JGRV JG RETIF MTR C/ CAB DE FIBRA

11807-JRSC JG JTA MTR C/ CAB DE FIBRA E C/ RET

11807-JRRV JG RETIF MTR C/ CAB DE FIBRA E RET

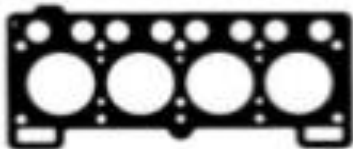

11802 SC - 1,4 MM - CIL. 78 MM
11802 KT - 2,4 MM - CIL. 78 MM
11802 TB - 1,9 MM - CIL. 78 MM
JTA CABEÇOTE
Nº ORIG: 84AV6051B



11635 BC
JG BORRACHAS TAMPA
VÁLVULAS
Nº ORIG: 65583



11052 NA
JTA VÁLVULA
TERMOSTÁTICA



11226 BO
JTA TAMPA VÁLVULAS
Nº ORIG: BDIM6584



46024 PAK / FA / FF
JTA ESCAPE



11822 PAK



11830 NA
JTA TRAS.



11030 PAK
11030 NA
JTA PEQUENA
ADMISSÃO



11821 PAK
11821 CC
JTA COLETOR ESCAPE



11831 NA
JTA BBA
DAGUA
Nº ORIG:



11655 NA
JTA BBA D
AGUA
Nº
ORIG:84AV85

JG JTA RETIFICAÇÃO



11832 NA
JTA BBA
AGUA
Nº ORIG:



11272 NA
JTA BBA
COMBUSTIVEL
Nº ORIG:



11632 CB
JTA BOCAL
ÓLEO



11636 GV
JTA BBA
ÓLEO



11833 GV
JTA
DISTRIBUI
DOR
Nº ORIG:



261420
ANEL BUJÃO CARTER
Nº ORIG: D7FZ6734A



11625 FL
JTA CAMISA
Nº ORIG: BD9M6C055A



11226 PV
11226 CB
JTA DA DISTRIBUIÇÃO



11816 CB
JG JTA CARTER
Nº ORIG: 845U6781A

11807-KP

KIT PARAFUSOS DO CABEÇOTE

11806-KTRT

KIT DE RETENORES DO MOTOR

RET VÁLVULAS-07X11X10,5



1212919

RET. DIANT GIRABREQUIM - RET. GIRABREQUIM TRASEIRO

35X50X08

82X105X12



1112456



1111945

1.6 8V 4C - KA 97/ - FIESTA 99/ - ESCORT 00/ - FOCUS 03/ - MTR ZETEC ROCAN - GAS / FLEX

| | | | |
|------------|-------------------------------------|------------|------------------------------------|
| 11005-JGCB | JG JTA MTR S/ CAB | 11005-JGRS | JG RETIF MTR S/ CAB |
| 11005-JGSC | JG JTA MTR C/ CAB DE FIBRA | 11005-JGRV | JG RETIF MTR C/ CAB DE FIBRA |
| 11005-JGML | JG JTA MTR C/ CAB DE CHAPA | 11005-JGRM | JG RETIF MTR C/ CAB DE CHAPA |
| 11005-JRSC | JG JTA MTR C/ CAB DE FIBRA E C/ RET | 11005-JRRV | JG RETIF MTR C/ CAB DE FIBRA E RET |
| 11005-JRML | JG JTA MTR C/ CAB DE CHAPA E C/ RET | 11005-JRRM | JG RETIF MTR C/ CAB DE CHAPA E RET |



11002 SC - 1,2 MM - CIL. 83 MM
 11002 KT - 2,2 MM - CIL. 83MM
 11002 MLS - 0,5 MM - CIL. 83 MM
 11002 MLS-2M - 1,5 MM - CIL. 83 MM
 11002-TB - 1,7 MM - CIL. 83 MM
 JTA DO CABEÇOTE



11121 JGBO
 JG JTA ADMISSÃO
 Nº ORIG: XS6E9441AB



11087 BO
 ANEL
 TERMOSTATO

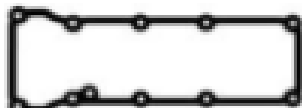

11626 BO
 JTA TAMPAS VALVULAS
 Nº ORIG: XS6E8255AB



11123 OR
 11123 F
 JTA DO COLETOR DE ESCAPE
 Nº ORIG: XS6E9448AC



11425 OR
 11425 F
 JTA ESCAPE
 Nº ORIG: XS619451DC



11843 BO
 JTA CARÇAÇA
 TERMOSTATO
 Nº ORIG:



11040 NA
 JTA SUPORTE
 BBA ÓLEO
 Nº ORIG:

JG JTA RETIFICAÇÃO



11429 NA
 JTA DISTRIBUIÇÃO



OR1-117
 ANEL ORING
 20,29 X 2,62



11092 BO
 VEDADOR VÁLVULA DE DESVIO
 Nº ORIG: 958F9F670BB

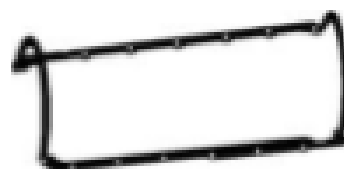

11016 BI
 11016 BA
 JTA DO CARTER

11004-KP
 KIT PARAFUSOS DO CABEÇOTE

11004-KTRT 11004 KTRT-F (com ret flange tras.)
 KIT DE RETENORES DO MOTOR

RET VALVULAS-06X11X18,5



1212919

RET. DIANT GIRABREQUIM - FLANGE TRASEIRO

40X62X7,5



1130045



11004 FR

1.5 16V 4C - KA / KA+ 15/ : MTR **SIGMA / HWDB / FLYA** - FLEX

1.6 16V 4C - FOCUS 07/- NEW FIESTA / ECOSPORT 11/13 - MTR **SIGMA / HWDB / FLYA** - FLEX

| | | | |
|------------|-------------------------------------|------------|------------------------------------|
| 12506-JGCB | JG JTA MTR S/ CAB | 12506-JGRS | JG RETIF MTR S/ CAB |
| 12506-JGSC | JG JTA MTR C/ CAB DE FIBRA | 12506-JGRV | JG RETIF MTR C/ CAB DE FIBRA |
| 12506-JRSC | JG JTA MTR C/ CAB DE FIBRA E C/ RET | 12506-JRRV | JG RETIF MTR C/ CAB DE FIBRA E RET |
| 12506-JGML | JG JTA MTR C/ CAB DE CHAPA | 12506-JGRM | JG RETIF MTR C/ CAB DE CHAPA |
| 12506-JRML | JG JTA MTR C/ CAB DE CHAPA E C/ RET | 12506-JRRM | JG RETIF MTR C/ CAB DE CHAPA E RET |



12501 SC - 1,2 MM - CIL. 80 MM
12501 MLS - 0,5 MM - CIL. 80 MM
 JTA CABEÇOTE
 Nº ORIG: 7S7G6051CB

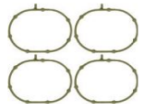

12520 JGBO
 JG JTA ADMISSÃO
 Nº ORIG: 96MM9441AD



11431 NA
 JTA TAMPA LATERAL DO CABEÇOTE



12537 F
 JTA CATALIZADOR
 Nº ORIG: 256194451AC

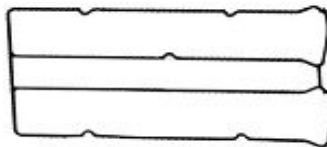

12526 BO
 JTA TAMPA VÁLVULAS
 Nº ORIG: 156G6K260A



12521 F
 JTA COLETOR ESCAPE



11534 BO
 JTA VENTILAÇÃO DO CARTER



12578 BO
 JTA CORPO BORBOLETA
 Nº ORIG:



12531 BO
 JTA VÁLVULA TRMSTÁTICA
 Nº ORIG:



12532 BO
 JTA CONEXÃO 3BA D

12506 KTBO

JG JTA RETIFICAÇÃO



11528 NA
 JTA DISTRIBUIÇÃO
 Nº ORIG:



11529 NA
 JTA BBA AGUA
 Nº ORIG: 98MM8507CC



46247 FA
 ANEL BUJÃO CARTER
 Nº ORIG: F70Z6675AA

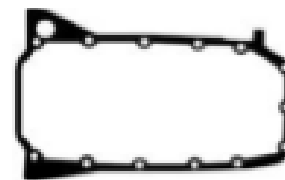

11516 BA
11516 CBLT
11516 NA
 JTA CARTER

11803-KP
KIT PARAFUSOS DO CABEÇOTE

11803-KTRT OU 11803 KTRT-F (com ret flange tras.)
KIT DE RETENORES DO MOTOR

RET VALV-06X11X16,5



1230043

RETENTOR DIANT GIRABREQUIM

33X47X05



1130143

RET COMANDO-38X52X07



1130043

FLANGE TRASEIRO



1130243

1.6 16V 4C - NEW FIESTA / ECOSPORT / FOCUS 13/ - MTR ZETEC-S (16HDEZ) SIGMA FLEX

| | | | |
|------------|-------------------------------------|------------|------------------------------------|
| 12507-JGCB | JG JTA MTR S/ CAB | 12507-JGRS | JG RETIF MTR S/ CAB |
| 12507-JGSC | JG JTA MTR C/ CAB DE FIBRA | 12507-JGRV | JG RETIF MTR C/ CAB DE FIBRA |
| 12507-JGML | JG JTA MTR C/ CAB DE CHAPA | 12507-JGRM | JG RETIF MTR C/ CAB DE CHAPA |
| 12507-JRSC | JG JTA MTR C/ CAB DE FIBRA E C/ RET | 12507-JRRV | JG RETIF MTR C/ CAB DE FIBRA E RET |
| 12507-JRML | JG JTA MTR C/ CAB DE CHAPA E C/ RET | 12507-JRRM | JG RETIF MTR C/ CAB DE CHAPA E RET |



12501 SC - 1,2 MM - CIL. 80 MM
12501 MLS - 0,5 MM - CIL. 80 MM
JTA CABEÇOTE
Nº ORIG: 7S7G6051CB

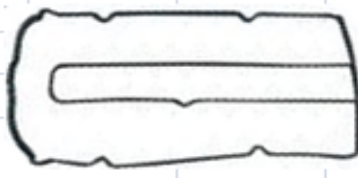

12525 BO
JTA TAMPÁ VÁLVULAS
Nº ORIG: 156G6K260A



12521 F
JTA COLETOR ESCAPE



12520 JGBO
JG JTA ADMISSÃO
Nº ORIG:
96MM9441AD



11431 NA
JTA TAMPÁ LATERAL DO CABEÇOTE



12537 F
JTA CATALIZADOR
Nº ORIG: 256194451AC



11534 BO
JTA VENTILAÇÃO DO CARTER



12578 BO
JTA CORPO BORBOLETA
Nº ORIG:



12531 BO
JTA VÁLVULA TRMOSTÁTICA
Nº ORIG:



12532 BO
JTA CONEXÃO BBA D

12506 KTBO
KIT DE BORRACHAS DO MOTOR

JG JTA RETIFICAÇÃO



11528 NA
JTA DISTRIBUIÇÃO
Nº ORIG:
96MM6659AD



11529 NA
JTA BBA AGUA
Nº ORIG: 98MM8507CC



46247 FA
ANEL BUJÃO CARTER
Nº ORIG: F70Z6675AA

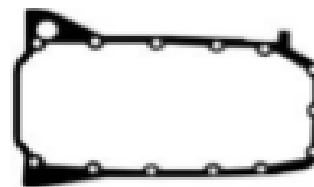

11516 BA
11516 CBLT
11516 NA
JTA CARTER

11803-KP KIT PARAFUSOS DO CABEÇOTE

12507-KTRT 12507 KTRT-F (com ret flange tras.) KIT DE RETENORES DO MOTOR

RET VALV-06X11X16,5



1230043

RETENTOR DIANT GIRABREQUIM

33X47X05



1130143

RET COMANDO-45X56,4X07



1130084

FLANGE TRASEIRO



1130243

1.8 16V 4C - ESCORT / MONDEO - MTR ZETEC (DOHC) - GAS

| | | | |
|------------|-------------------------------------|------------|------------------------------------|
| 11706-JGCB | JG JTA MTR S/ CAB | 11706-JGRS | JG RETIF MTR S/ CAB |
| 11706-JGSC | JG JTA MTR C/ CAB DE FIBRA | 11706-JGRV | JG RETIF MTR C/ CAB DE FIBRA |
| 11706-JGML | JG JTA MTR C/ CAB DE CHAPA | 11706-JGRM | JG RETIF MTR C/ CAB DE CHAPA |
| 11706-JRSC | JG JTA MTR C/ CAB DE FIBRA E C/ RET | 11706-JRRV | JG RETIF MTR C/ CAB DE FIBRA E RET |
| 11706-JRML | JG JTA MTR C/ CAB DE CHAPA E C/ RET | 11706-JRRM | JG RETIF MTR C/ CAB DE CHAPA E RET |

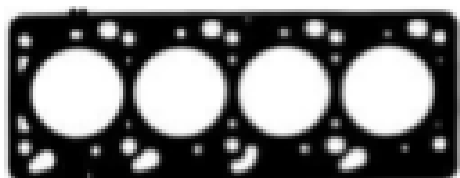

11101 SC - 2,0 MM - CIL. 83 MM
11101 KT - 3,0 MM - CIL. 83 MM
11101 MLS - 1,9 MM - CIL. 83 MM
11101 MLS-2M - 2,9 MM - CIL. 83 MM
JTA CABEÇOTE

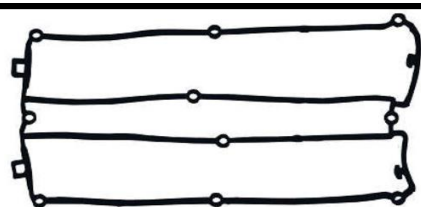

11526 BO-JTA TAMPAS VÁLVULA



11026 JGBO-JG BARRA PARAFUSOS TV



11331 PAK / F
JTA COLETOR ESCAPE
Nº ORIG: 938M9448AA



11320 JGBO
JG JTA ADMISSÃO
Nº ORIG: 988M9461AA

11526 KTBO - KIT DE JUNTAS DA TAMPAS DE VÁLVULAS

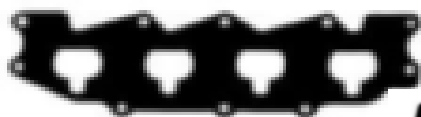

11441 PAK
BAQUELITE ADMISSÃO
Nº ORIG: 988M9461AA



11043 NA
JTA INJEÇÃO



11451 NA
JTA ADMISSÃO
Nº ORIG: 938M9448AA



11044 NA
JTA BBA D AGUA
Nº ORIG:
968M8507AB



11045 NA
JTA TERMOSTATO

JG JTA RETIFICAÇÃO



11039 NA
JTA BBA ÓLEO
Nº ORIG:
968M6659AB



11038 NA
JTA MANCAL
TRASEIRO
Nº ORIG:
928M6344AA



261622
ANEL BUJÃO
CARTER
16,2 X 22 X 1,5



11046 NA
JTA BBA ÓLEO
Nº ORIG:
928M6625AA



11048 NA
JTA TUBO
SEPARAÇÃO
ÓLEO CARTER

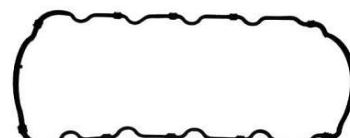

11916 BO
JTA CARTER

11706-KP

KIT PARAFUSOS DO CABEÇOTE

11706-KTRT

KIT DE RETENORES DO MOTOR

RET VALV-06X12X19,5



1230049

RETENTOR DIANT GIRABREQUIM

35X50X08



1112456

RET COMANDO-42X53X07



1130149

FLANGE TRASEIRO

88X108X10



1130249

1.8 16V 4C - FOCUS / MONDEO 1.8 16V 00/05 - MTR ZETEC-E (DOHC) - GAS

| | | | |
|------------|-------------------------------------|------------|------------------------------------|
| 11108-JGCB | JG JTA MTR S/ CAB | 11108-JGRS | JG RETIF MTR S/ CAB |
| 11108-JGSC | JG JTA MTR C/ CAB DE FIBRA | 11108-JGRV | JG RETIF MTR C/ CAB DE FIBRA |
| 11108-JGML | JG JTA MTR C/ CAB DE CHAPA | 11108-JGRM | JG RETIF MTR C/ CAB DE CHAPA |
| 11108-JRSC | JG JTA MTR C/ CAB DE FIBRA E C/ RET | 11108-JRRV | JG RETIF MTR C/ CAB DE FIBRA E RET |
| 11108-JRML | JG JTA MTR C/ CAB DE CHAPA E C/ RET | 11108-JRRM | JG RETIF MTR C/ CAB DE CHAPA E RET |

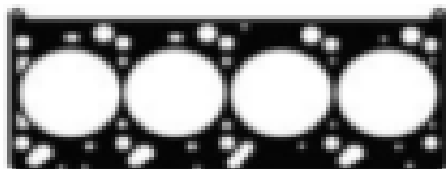

11101 SC - 2,0 MM - CIL. 83 MM
 11101 KT - 3,0 MM - CIL. 83 MM
 11101 MLS - 1,9 MM - CIL. 83 MM
 11101 MLS-2M - 2,9 MM - CIL. 83 MM

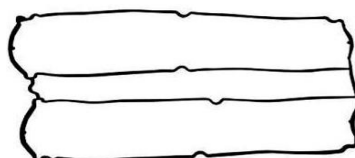

11525 BO
 JTA TAMPÁ VÁLVULAS



11522 PAK
 11522 F
 JTA COLETOR ESCAPE



11520 JGBO
 JG JTA ADMISSÃO
 NºORIG: 988M9461MAA



11043 NA
 JTA INJEÇÃO



11044 NA
 JTA BBA D AGUA
 Nº ORIG: 968M8507AB



11095 BO
 ANEL INJEÇÃO
 ELETRÔNICA



11048 NA
 JTA TUBO SEPARAÇÃO ÓLEO
 CARTER

JG JTA RETIFICAÇÃO



11045 NA
 JTA TERMOSTATO
 Nº ORIG:
 928M8255AA



11046 NA
 JTA BBA ÓLEO



261620
 ANEL BUJÃO CARTER
 16,2 X 19 X 1,5 MM



OR1-225
 ANEL ORING



OR1-210
 ANEL ORING
 19 X 3,53 MM



11038 NA
 JTA MANCAL TRASEIRO
 Nº ORIG: 928M6344AA



11041 NA
 JTA BBA ÓLEO



11517 NA
 JTA SUB CARTER



11117 BA
 JTA CARTER
 Nº ORIG: 1078707

11706-KP

KIT PARAFUSOS DO CABEÇOTE

11706-KTRT

KIT DE RETENORES DO MOTOR

RET VALV-06X12X19,5



1230049

RETENTOR DIANT GIRABREQUIM

35X50X08



1112456

RET COMANDO-42X53X07



1130149

FLANGE TRASEIRO

88X108X10



1130249

2.0 16V 4C - ESCORT / MONDEO - MTR ZETEC (DOHC) - GAS

| | | | |
|------------|-------------------------------------|------------|------------------------------------|
| 11707-JGCB | JG JTA MTR S/ CAB | 11707-JGRS | JG RETIF MTR S/ CAB |
| 11707-JGSC | JG JTA MTR C/ CAB DE FIBRA | 11707-JGRV | JG RETIF MTR C/ CAB DE FIBRA |
| 11707-JGML | JG JTA MTR C/ CAB DE CHAPA | 11707-JGRM | JG RETIF MTR C/ CAB DE CHAPA |
| 11707-JRSC | JG JTA MTR C/ CAB DE FIBRA E C/ RET | 11707-JRRV | JG RETIF MTR C/ CAB DE FIBRA E RET |
| 11707-JRML | JG JTA MTR C/ CAB DE CHAPA E C/ RET | 11707-JRRM | JG RETIF MTR C/ CAB DE CHAPA E RET |



11102 SC - 2,0 MM - CIL. 86 MM
 11102 KT - 3,0 MM - CIL. 86 MM
 11102 MLS - 1,9 MM - CIL. 86 MM
 11102 MLS-2M - 2,9 MM - CIL 86 MM
 JTA CABEÇOTE

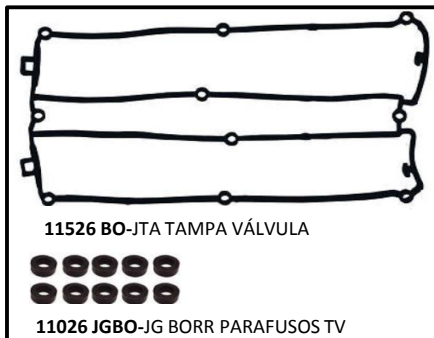

11526 BO-JTA TAMPA VÁLVULA

11026 JGBO-JG BARRA PARAFUSOS TV



11331 PAK / F
 JTA COLETOR ESCAPE
 Nº ORIG: 938M9448AA



11320 JGBO
 JG JTA ADMISSÃO
 Nº ORIG: 988M9461AA

11526 KTBO - KIT DE JUNTAS DA TAMPA DE VÁLVULAS

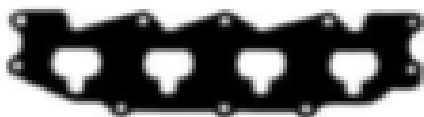

11441 PAK
 BAQUELITE ADMISSÃO
 Nº ORIG: 988M9461AA



11451 NA
 JTA INJEÇÃO
 ELETRÔNICA
 Nº ORIG: 938M9448AA



11043 NA
 JTA BBA D AGUA
 Nº ORIG:



11044 NA
 JTA TERMOSTATO
 Nº ORIG: 968M8507AB



11045 NA
 JTA TERMOSTATO
 Nº ORIG:

JG JTA RETIFICAÇÃO



11039 NA
 JTA BBA ÓLEO
 Nº ORIG: 968M6659AB



11038 NA
 JTA MANCAL
 TRASEIRO
 Nº ORIG: 928M6344AA



261622
 ANEL BUJÃO
 CARTER
 16,2 X 22 X 1,5



11046 NA
 JTA BBA ÓLEO
 Nº ORIG: 928M6625AA



11048 NA
 JTA TUBO
 SEPARAÇÃO
 ÓLEO CARTER



11916 BO
 JTA CARTER

11706-KP KIT PARAFUSOS DO CABEÇOTE

11706-KTRT KIT DE RETENORES DO MOTOR

RET VALV-06X12X19,5



1230049

RETENTOR DIANT GIRABREQUIM

35X50X08



1112456

RET COMANDO-42X53X07



1130149

FLANGE TRASEIRO

88X108X10



1130249

2.0 16V 4C - FOCUS / MONDEO : 00/05 - MTR ZETEC-E (DOHC)

| | | | |
|------------|-------------------------------------|------------|------------------------------------|
| 11109-JGCB | JG JTA MTR S/ CAB | 11109-JGRS | JG RETIF MTR S/ CAB |
| 11109-JGSC | JG JTA MTR C/ CAB DE FIBRA | 11109-JGRV | JG RETIF MTR C/ CAB DE FIBRA |
| 11109-JGML | JG JTA MTR C/ CAB DE CHAPA | 11109-JGRM | JG RETIF MTR C/ CAB DE CHAPA |
| 11109-JRSC | JG JTA MTR C/ CAB DE FIBRA E C/ RET | 11109-JRRV | JG RETIF MTR C/ CAB DE FIBRA E RET |
| 11109-JRML | JG JTA MTR C/ CAB DE CHAPA E C/ RET | 11109-JRRM | JG RETIF MTR C/ CAB DE CHAPA E RET |

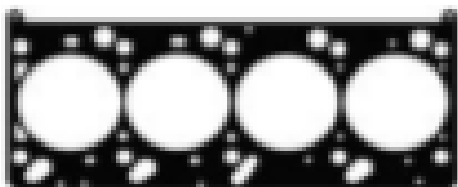

11102 SC - 2,0 MM - CIL. 86 MM
 11102 KT - 3,0 MM - CIL. 86 MM
 11102 MLS - 1,9 MM - CIL. 86 MM
 11102 MLS-2M - 2,9 MM - CIL 86 MM
 JTA CABEÇOTE

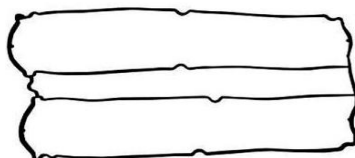

11525 BO
 JTA TAMPA VÁLVULAS



11522 PAK
 11522 F



11520 JGBO
 JG JTA ADMISSÃO
 NºORIG: 988M9461MAA



11095 BO
 ANEL INJEÇÃO
 ELETRÔNICA



11044 NA
 JTA BBA D AGUA
 Nº ORIG: 968M8507AB



11043 NA
 JTA INJEÇÃO
 ELETRÔNICA



11048 NA
 JTA TUBO SEPARAÇÃO ÓLEO CARTER

JG JTA RETIFICAÇÃO



11045 NA
 JTA TERMOSTATO
 Nº ORIG:



11046 NA
 JTA BBA ÓLEO
 Nº ORIG: 928M6625AA



261620
 ANEL BUJÃO CARTER
 16,2 X 19 X 1,5 MM



OR1-225
 ANEL ORING



OR1-210
 ANEL ORING
 19 X 3,53 MM



11038 NA
 JTA MANCAL TRASEIRO
 Nº ORIG: 928M6344AA



11041 NA
 JTA BBA ÓLEO



11517 NA
 JTA SUB CARTER



11117 BA
 JTA CARTER
 Nº ORIG: 1078707

11706-KP KIT PARAFUSOS DO CABEÇOTE

11706-KTRT KIT DE RETENORES DO MOTOR

RET VALV-06X12X19,5



1230049

RETENTOR DIANT GIRABREQUIM

35X50X08



1112456

RET COMANDO-42X53X07



1130149

FLANGE TRASEIRO

88X108X10



1130249

2.0 16V 4C - ECOSPORT 02/ - MONDEO 98/01 - VOLVO C30 / S40 / V50 - DURATEC-HE CJBA (TPA.VÁLV.PLÁSTICO)

| | | | |
|------------|-------------------------------------|------------|------------------------------------|
| 12207-JGCB | JG JTA MTR S/ CAB | 12207-JGRS | JG RETIF MTR S/ CAB |
| 12207-JGSC | JG JTA MTR C/ CAB DE FIBRA | 12207-JGRV | JG RETIF MTR C/ CAB DE FIBRA |
| 12207-JGML | JG JTA MTR C/ CAB DE CHAPA | 12207-JGRM | JG RETIF MTR C/ CAB DE CHAPA |
| 12207-JRSC | JG JTA MTR C/ CAB DE FIBRA E C/ RET | 12207-JRRV | JG RETIF MTR C/ CAB DE FIBRA E RET |
| 12207-JRML | JG JTA MTR C/ CAB DE CHAPA E C/ RET | 12207-JRRM | JG RETIF MTR C/ CAB DE CHAPA E RET |

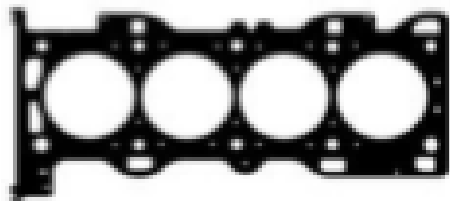

12201 SC - 1,2 MM - CIL. 88 MM
 12201 KT - 2,2 MM - CIL. 88 MM
 12201 MLS - 0,5 MM - CIL. 88 MM
 12201 MLS-2M - 1,5 MM - CIL. 88 MM
 JTA CABEÇOTE

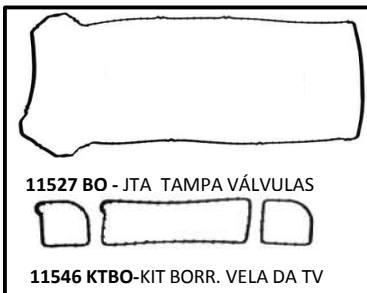

11527 BO - JTA TAMPA VÁLVULAS

11546 KTBO-KIT BORR. VELA DA TV

11527 KTBO - KIT DE JTAS DA T V



12221 F
 JTA COLETOR ESCAPE
 Nº ORIG: 157G9448AD



12220 JGBO
 JG JTA ADMISSÃO
 Nº ORIG: 157Z9439AA



12222 F
 JTA ESCAPE



12285 BO
 VEDADOR ARANHA /
 CAIXA BORBOLETA



11155 NA
 CONEXÃO SAÍDA D AGUA

JG JTA RETIFICAÇÃO



11153 NA
 JTA SUPORTE FILTRO ÓLEO
 Nº ORIG: 157Z6840AA



11154 NA
 JTA



12247 BO
 ANEL DO BUJÃO
 DO CARTER



11158 NA
 JTA VÁLVULA REGULADORA
 VENTILAÇÃO MOTOR
 Nº ORIG: 157Z9D476AA



OR1-225
 ANEL ORING
 47,22 X 3,53 MM



OR1-210
 ANEL ORING
 19 X 3,53 MM

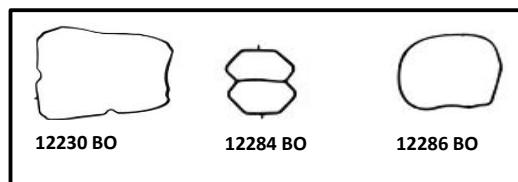

12230 BO

12284 BO

12286 BO

12207 KTBO

12207-KP KIT PARAFUSOS DO CABEÇOTE

12207-KTRT OU 12207 KTRT-F (com ret flange tras.) KIT DE RETENORES DO MOTOR RET VALV-5,5X11X18,5



1230073

RETENOR DIANT GIRABREQUIM 37X50X08



1130073

FLANGE TRASEIRO



1130273

2.0 16V 4C - MONDEO / ECOSPORT : 02/05 - MTR DURATEC-HE - (TPA VÁL. DE ALUMÍNIO) - GAS

2.3 16V 4C - RANGER / FUSION : 98/04 - MTR DURATEC-HE - (TPA VÁL. DE ALUMÍNIO) - GAS

| | | | |
|------------|-------------------------------------|------------|------------------------------------|
| 12209-JGCB | JG JTA MTR S/ CAB | 12209-JGRS | JG RETIF MTR S/ CAB |
| 12209-JGSC | JG JTA MTR C/ CAB DE FIBRA | 12209-JGRV | JG RETIF MTR C/ CAB DE FIBRA |
| 12209-JGML | JG JTA MTR C/ CAB DE CHAPA | 12209-JGRM | JG RETIF MTR C/ CAB DE CHAPA |
| 12209-JRSC | JG JTA MTR C/ CAB DE FIBRA E C/ RET | 12209-JRRV | JG RETIF MTR C/ CAB DE FIBRA E RET |
| 12209-JRML | JG JTA MTR C/ CAB DE CHAPA E C/ RET | 12209-JRRM | JG RETIF MTR C/ CAB DE CHAPA E RET |



12202 SC - 1,2 MM - CIL. 88 MM
 12202 KT - 2,2 MM - CIL. 88 MM
 12202 MLS - 0,5 MM - CIL. 88 MM
 12202 MLS-2M - 1,5 MM - CIL. 88 MM
 JTA CABEÇOTE



12222 F
 JTA ESCAPE

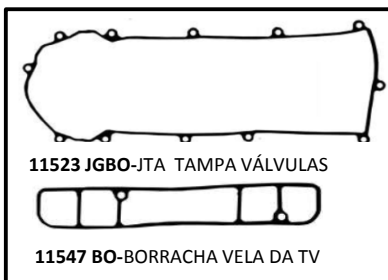

11523 JGBO-JTA TAMPA VÁLVULAS



11547 BO-BORRACHA VELA DA TV

11523 KTBO-KIT DE JTAS DA T V



12285 BO
 VEDADOR ARANHA /
 CAIXA BORBOLETA



11155 NA
 JTA CONEXÃO SAÍDA D AGUA
 Nº ORIG: 157G8255BD



12221 F
 JTA COLETOR ESCAPE
 Nº ORIG: 157G9448AD



12220 JGBO
 JG JTA ADMISSÃO
 Nº ORIG: 157Z9439AA

JG JTA RETIFICAÇÃO



11153 NA
 JTA SUPORTE FILTRO ÓLEO
 Nº ORIG: 157Z6840AA



11154 NA
 JTA



12247 BO
 ANEL DO BUIÃO
 DO CARTER



11158 NA
 JTA VÁLVULA REGULADORA
 VENTILAÇÃO MOTOR
 Nº ORIG: 157Z9D476AA



OR1-225
 ANEL ORING
 47,22 X 3,53 MM



OR1-210
 ANEL ORING
 19 X 3,53 MM

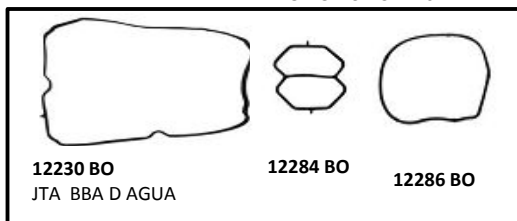

12230 BO
 JTA BBA D AGUA

12284 BO

12286 BO

12207 KTBO

12207-KP
 KIT PARAFUSOS DO CABEÇOTE

12207-KTRT OU 12207 KTRT-F (com ret flange tras.)
 KIT DE RETENORES DO MOTOR
 RET VALV-5,5X11X18,5



1230073

RETENTOR DIANT GIRABREQUIM
 37X50X08



1130073

FLANGE TRASEIRO



12207 FR

2.2 8V 4C - WILLYS JEEP 4 CILS. 48 /53 - MTR MILITAR (CONTINENTAL) - GAS

13006-JGCB JG JTA MTR S/ CAB

13006-JGRS JG RETIF MTR S/ CAB

13006-JGSC JG JTA MTR C/ CAB DE FIBRA

13006-JGRV JG RETIF MTR C/ CAB DE FIBRA



13001 SC
JTA CABEÇOTE
Nº ORIG: 638540



13026 PAK
JTA ENTRE COLETORES
NºORIG:634811



13130 CB
JTA TAMPA VÁLVULAS
Nº ORIG: 630305



13027 PAK
JTA ESCAPE
NºORIG:11499



13021 PAK
JTA COLETOR ESCAPE
Nº ORIG: 638640

JG JTA RETIFICAÇÃO



13031 GV
JTA BBA AGUA
Nº ORIG: 637053



13331 GV
JTA BBA OLEO
Nº ORIG: 11484



59840 NA
JTA TUBO ÓLEO
Nº ORIG: 4632138



10296 NA
JTA BBA COMBÚSTIVEL
Nº ORIG: 11484D42E9417



13033 NA
JTA



13035 NA
JTA



13335 NA
JTA SUPORTE BÓIA BBA ÓLEO
Nº ORIG: 11493



13036 BO
VBORRACHA LATERAL MANCAL
Nº ORIG: 637790



70019 A
GAXETA MANCAL TRAS.
Nº ORIG: B24489



13132CB
JTA DISTRIBUIÇÃO
Nº ORIG: 630365



13034 NA
JTA BBA COMB
Nº ORIG: 630359



13116 CB
JTA CARTER

XXXXX-KP
KIT PARAFUSOS DO CABEÇOTE

2.2 8V 4C - JEEP 54/58 MTR HURICANE - GAS

13106-JGCB JG JTA MTR S/ CAB

13106-JGRS JG RETIF MTR S/ CAB

13106-JGSC JG JTA MTR C/ CAB DE FIBRA

13106-JGRV JG RETIF MTR C/ CAB DE FIBRA



13101 SC
JTA CABEÇOTE
Nº ORIG: 638540



13128 CB
JTA TAMPA VÁLVULAS
Nº ORIG: 648798



13130 CB
JTA TAMPA LATERAL VÁLVULAS
Nº ORIG: 630305

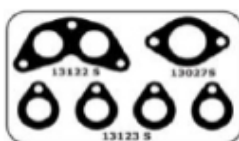

13121 PAK
JG JTA COLETOR ESCAPE

JG JTA RETIFICAÇÃO



13031 GV
JTA BBA AGUA
Nº ORIG: 637053



13331 GV
JTA BBA OLEO
Nº ORIG: 11484



13334 GV
JTA TAMPA BBA OLEO
Nº ORIG: 11484



10296 NA
JTA BBA COMBÚSTIVEL
Nº ORIG: 11484D42E9417



10420 NA
JTA FLANGE CARBURADOR
Nº ORIG: 638644



13336 CB
JTA RESPIRO
CARTER
Nº ORIG: 11478



262230
ANEL BUJÃO
CARTER



13333 GV
JTA VÁLVULA
TERMOSTÁTICA
Nº ORIG: 11487



13335 NA
JTA SUPORTE BÓIA BBA ÓLEO
Nº ORIG: 11493



13036 BO
BORRACHA LATERAL MANCAL
Nº ORIG: 637790



70019 A
GAXETA MANCAL TRAS.
Nº ORIG: B24489



13132CB
JTA DISTRIBUIÇÃO
Nº ORIG: 630365



13034 NA
JTA BBA COMB
Nº ORIG: 630359



13116 CB
JTA CARTER

XXXXX-KP
KIT PARAFUSOS DO CABEÇOTE

2.2 16V 4C - RANGER 11/12 - MOTOR : DURATORQ / PUMA / TDCI (22DDOP) / GBVAJPF/QW/QJ -DIESEL

| | | | |
|------------|-------------------------------------|------------|------------------------------------|
| 12705-JGCB | JG JTA MTR S/ CAB | 12705-JGRS | JG RETIF MTR S/ CAB |
| 12705-JGSC | JG JTA MTR C/ CAB DE FIBRA | 12705-JGRV | JG RETIF MTR C/ CAB DE FIBRA |
| 12705-JGML | JG JTA MTR C/ CAB DE CHAPA | 12705-JGRM | JG RETIF MTR C/ CAB DE CHAPA |
| 12705-JRSC | JG JTA MTR C/ CAB DE FIBRA E C/ RET | 12705-JRRV | JG RETIF MTR C/ CAB DE FIBRA E RET |
| 12705-JRML | JG JTA MTR C/ CAB DE CHAPA E C/ RET | 12705-JRRM | JG RETIF MTR C/ CAB DE CHAPA E RET |



12701-1M-MLS - 1,10 MM - CIL. 87 MM
 12701-2M-MLS - 1,15 MM - CIL. 87 MM
 12701-3M-MLS - 1,20 MM - CIL. 87 MM
 12701-3M-SC - 1,20 MM - CIL. 87 MM



12721 MLS
JTA COLETOR ESCAPE



12725 BO



12745 JGBO VED. BICO VELAS
 12746 JGBO VED PARAFUSOS

12725 KTBO-KIT DE JTAS DA T V



12749 DI-DIAFRAGMA DA T V

12725 KTBO-DI-KIT DE JTAS T V C/ DIAFRAGMA



12720 JGBO
JG JTA ADMISSÃO

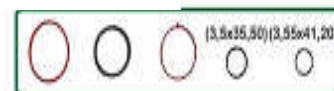

12705 KTBO
KIT VEDADORES MOTOR



12722 PAK - JTA DE ESCAPE

JG JTA RETIFICAÇÃO



12733 PAK
JTA



12736 MLS
JTA



12741 PAK
JTA



12742 MLS
JTA



12743 MLS
JTA



12737 MLS
JTA



12748 MLS
JTA



12747 BO
JUNTA DA
TAMPA



12744 MLS
JTA



12727 NA



12728 NA
JTA DISTRIBUIÇÃO INTERNA

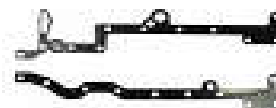

12716 MLS

XXXXX-KP
KIT PARAFUSOS DO CABEÇOTE

12705-KTRT OU 12705 KTRT-F (com ret flange tras.)
KIT DE RETENTORES DO MOTOR

RET VALVULAS-07X12X19,5



1230083

FLANGE TRASEIRO



12705 FR

RET DIANT
50X90X8,5/13,5



1130183

2.2 16V 4C - RANGER 13/ MTR: GBVAJPF/AQL/AQN / DURATORQ - TRANSIT 07/ - MTR UHF/A/B/C - DIESEL

| | | | |
|------------|-------------------------------------|------------|------------------------------------|
| 12708-JGCB | JG JTA MTR S/ CAB | 12708-JGRS | JG RETIF MTR S/ CAB |
| 12708-JGSC | JG JTA MTR C/ CAB DE FIBRA | 12708-JGRV | JG RETIF MTR C/ CAB DE FIBRA |
| 12708-JGML | JG JTA MTR C/ CAB DE CHAPA | 12708-JGRM | JG RETIF MTR C/ CAB DE CHAPA |
| 12708-JRSC | JG JTA MTR C/ CAB DE FIBRA E C/ RET | 12708-JRRV | JG RETIF MTR C/ CAB DE FIBRA E RET |
| 12708-JRML | JG JTA MTR C/ CAB DE CHAPA E C/ RET | 12708-JRRM | JG RETIF MTR C/ CAB DE CHAPA E RET |



12701-1M-MLS - 1,10 MM - CIL. 87 MM
 12701-2M-MLS - 1,15 MM - CIL. 87 MM
 12701-3M-MLS - 1,20 MM - CIL. 87 MM
 12701-3M-SC - 1,20 MM - CIL. 87 MM



12721 MLS
JTA COLETOR ESCAPE



12726 BO



12745 JGBO
JTA BICO VELAS



12746 BO
VED PARAFUSOS

12726 KTBO
JTA TAMPA VÁLVULAS



12749 DI-DIAFRAGMA DA T V

12726 KTBO-DI -KIT DE JTAS T V C/ DIAFRAGMA

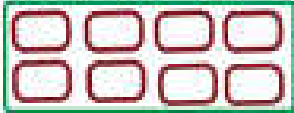

12720 JGBO
JG JTA ADMISSÃO



12705 KTBO
KIT VEDADORES MOTOR



12722 PAK - JTA DE ESCAPE

JG JTA RETIFICAÇÃO



12733 PAK
JTA



12730 MLS
JUNTA DA BOMBA D'AGUA



12734 MLS
JTA



12741 PAK
JTA



12742 MLS
JTA



12743 MLS
JTA



12737 MLS



12748 MLS
JTA



12747 BO
JUNTA DA TAMPA



12744 MLS
JTA



12727 NA



12728 NA
JTA DISTRIBUIÇÃO INTERNA



12716 MLS

XXXXX-KP
KIT PARAFUSOS DO CABEÇOTE

12705-KTRT OU 12705 KTRT-F (com ret flange tras.)
KIT DE RETENORES DO MOTOR

RET VALVULAS-07X12X19,5



1230083

FLANGE TRASEIRO



12705 FR

RET DIANT
50X90X8,5/13,5



1130183

2.3 8V 4C - JEEP / F-75 / MAVERICK / F100 : 75/82 - MTR SOHC - GAS

| | | | |
|------------|-------------------------------------|------------|------------------------------------|
| 11306-JGCB | JG JTA MTR S/ CAB | 11306-JGRS | JG RETIF MTR S/ CAB |
| 11306-JGSC | JG JTA MTR C/ CAB DE FIBRA | 11306-JGRV | JG RETIF MTR C/ CAB DE FIBRA |
| 11306-JRSC | JG JTA MTR C/ CAB DE FIBRA E C/ RET | 11306-JRRV | JG RETIF MTR C/ CAB DE FIBRA E RET |

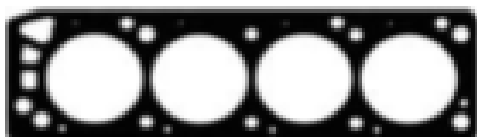

11301 SC - 1,6 MM - CIL. 99,5 MM
 11301 KT - 2,6 MM - CIL. 99,5 MM
 11301-TB - 2,1 MM - CIL. 99,5 MM
 JTA CABEÇOTE



11326 CB
 JTA TAMPA VÁLVULAS
 Nº ORIG: D52E6584AB



11323 PAK
 JTA COLETOR ESCAPE
 Nº ORIG: 78BR9448AA



11335 NA
 JTA CARB URADOR/
 ADMISSÃO



11322 NA - JTA ADMISSÃO(ALC)



11330 NA
 JTA TPA COL
 ADM
 Nº ORIG:
 D42E9E436AA



11332 NA
 JTA SAÍDA D
 AGUA
 Nº ORIG:
 D42E8255AA



11336 NA
 JTA BASE
 CARBURADOR



11323 NA
 JTA BASE
 CARBURADOR



11321 NA-JTA ADMISSÃO(GAS)

JG JTA RETIFICAÇÃO



11327 NA
 JTA VÁLV
 RECIRCULADORA
 Nº ORIG:
 D4DZ9D476A



11329 NA
 JTA BBA AGUA
 Nº ORIG:

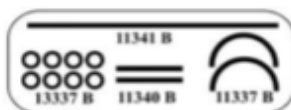

11306 KTBO
 KIT VEDADORES
 DO MOTOR



11338 NA
 JTA BBA OLEO
 Nº ORIG:
 D42E6625CA



10296 NA
 JTA BBA
 COMBUSTIVEL
 Nº ORIG:
 D42E9417AA



11324 NA
 JTA BUJÃO
 CARTER
 Nº ORIG:
 EDEE6734AA



11328 NA
 JTA DISTRIBUIÇÃO
 Nº ORIG:
 D42E6020AB



11325 GV
 JTA ADPTATOR
 FILTRO ÓLEO
 Nº ORIG:
 75BU6840A

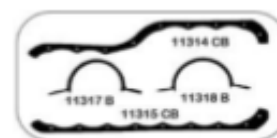

11316 CB
 JG JTA CARTER
 Nº ORIG: D42E6710AA

XXXXX-KP KIT PARAFUSOS DO CABEÇOTE

11306-KTRT KIT DE RETENORES DO MOTOR RET VÁLVULAS - RET COMANDO 43X56X09



11333 BO



1131943

RET GIRABREQUIM DIANTEIRO

43X56X09



1131943

2.3/2.5 8V 4C - FORD - RANGER 93/- MOTOR 140 WLT / SOHC - GAS

2.3/2.5 8V 4C - MAZDA - B2300 / B2500 - MOTOR 140 WLT / SOHC - GAS

11307-JGCB JG JTA MTR S/ CAB

11307--JGRS JG RETIF MTR S/ CAB

11307--JGSC JG JTA MTR C/ CAB DE FIBRA

11307--JGRV JG RETIF MTR C/ CAB DE FIBRA

11307--JRSC JG JTA MTR C/ CAB DE FIBRA E C/ RET

11307--JRRV JG RETIF MTR C/ CAB DE FIBRA E RET



11301 SC - 1,6 MM - CIL. 99,5 MM
11301 KT - 2,6 MM - CIL. 99,5 MM
11301-KT - 2,1 MM - CIL. 99,5 MM
JTA DO CABEÇOTE



11327 BO
JTA TAMPA VÁLVULAS



11325 PAK
JTA COLETOR ESCAPE



11324 NA
JTA ADMISSÃO



11319 NA
JTA ADMISSÃO INTERNA
Nº ORIG: D42E9417AA

JG JTA RETIFICAÇÃO



11339 NA
JTA ENTRADA AR



11334 NA
JTA BBA AGUA



11307 KT BO



11317 BO

11307-KTRT-8MM

KIT DE RETENORES DO MOTOR

RET VALVULAS-08X14X15



1230059

RET COMANDO-43X56X090



1131943

RET GIRABREQUIM DIANT

43X56X09



1131943

RET GIRABREQUIM TRAS.

92X108X9,5



1130059

11307-KTRT-7MM

KIT DE RETENORES DO MOTOR

RET VALVULAS-07X12X14



1230159

RET GIRABREQUIM DIANT

43X56X09



1131943

RET COMANDO-43X56X09



1131943

RET GIRABREQUIM TRAS.

92X108X9,5



1130059

2.3 16V 4C - RANGER / FUSION 2.3 16V MTR DURATEC - (TAMPA DE VÁLVULAS DE PLÁSTICO)

| | | | |
|------------|-------------------------------------|------------|------------------------------------|
| 12208-JGCB | JG JTA MTR S/ CAB | 12208-JGRS | JG RETIF MTR S/ CAB |
| 12208-JGSC | JG JTA MTR C/ CAB DE FIBRA | 12208-JGRV | JG RETIF MTR C/ CAB DE FIBRA |
| 12208-JGML | JG JTA MTR C/ CAB DE CHAPA | 12208-JGRM | JG RETIF MTR C/ CAB DE CHAPA |
| 12208-JRSC | JG JTA MTR C/ CAB DE FIBRA E C/ RET | 12208-JRRV | JG RETIF MTR C/ CAB DE FIBRA E RET |
| 12208-JRML | JG JTA MTR C/ CAB DE CHAPA E C/ RET | 12208-JRRM | JG RETIF MTR C/ CAB DE CHAPA E RET |



12202 SC - 1,2 MM - CIL. 88 MM
 12202 KT - 2,2 MM - CIL. 88 MM
 12202 MLS - 0,5 MM - CIL. 88 MM
 12202 MLS-2M - 1,5 MM - CIL. 88 MM
 JTA CABEÇOTE



12285 BO
 VEDADOR ARANHA /
 CAIXA BORBOLETA

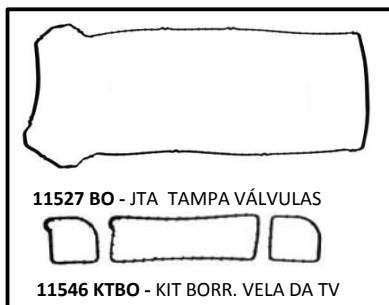

11527 BO - JTA TAMPA VÁLVULAS

11546 KTBO - KIT BORR. VELA DA TV

11527 KTBO - KIT DE JTAS DA T V



12222 F
 JTA ESCAPE



11155 NA
 JTA CONEXÃO SAÍDA D AGUA
 Nº ORIG: 157G8255BD



11221 F
 JTA COLETOR ESCAPE
 Nº ORIG: 157G9448AD



12220 JGBO
 JG JTA ADMISSÃO
 Nº ORIG: 15729439AA

JG JTA RETIFICAÇÃO



11153 NA
 JTA SUPORTE FILTRO ÓLEO
 Nº ORIG: 157Z6840AA



11154 NA
 JTA



12247 BO
 ANEL DO BUJÃO
 DO CARTER



11158 NA
 JTA VÁLVULA REGULADORA



OR1-225
 ANEL ORING
 47,22 X 3,53 MM



OR1-210
 ANEL ORING
 19 X 3,53 MM

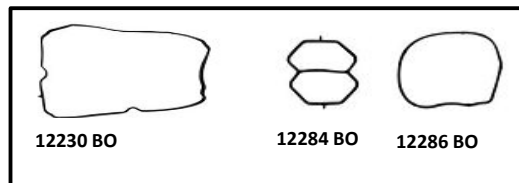

12230 BO

12284 BO

12286 BO

12207 KTBO

12207-KP KIT PARAFUSOS DO CABEÇOTE

12207-KTRT 12207 KTRT-F (com ret flange tras.) KIT DE RETENORES DO MOTOR

RET VALV-5,5X11X18,5



1230073

RETENTOR DIANT GIRABREQUIM

37X50X08



1130073

FLANGE TRASEIRO



12207 FR

FORD / LAND ROVER

2.4 16V 4C - FORD - TRANSIT TD/TDCI: 01/06-MTR: DURATORQ / DOFA / FXFA / FAA / B/C/D / H9FA / B/C-DIESEL

2.4 16V 4C - LAND ROVER-DEFENDER-MTR: DURATORQ / DOFA / FXFA / FAA / B / C / D / H9FA / B / C-DIESEL

| | | | |
|------------|-------------------------------------|------------|------------------------------------|
| 12705-JGCB | JG JTA MTR S/ CAB | 12705-JGRS | JG RETIF MTR S/ CAB |
| 12706-JGSC | JG JTA MTR C/ CAB DE FIBRA | 12706-JGRV | JG RETIF MTR C/ CAB DE FIBRA |
| 12706-JGML | JG JTA MTR C/ CAB DE CHAPA | 12706-JGRM | JG RETIF MTR C/ CAB DE CHAPA |
| 12706-JRSC | JG JTA MTR C/ CAB DE FIBRA E C/ RET | 12706-JRRV | JG RETIF MTR C/ CAB DE FIBRA E RET |
| 12706-JRML | JG JTA MTR C/ CAB DE CHAPA E C/ RET | 12706-JRRM | JG RETIF MTR C/ CAB DE CHAPA E RET |

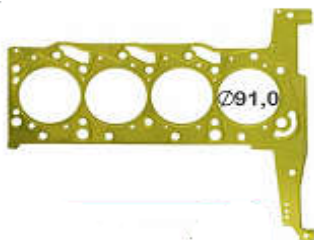

12702-1M-MLS - 1,10 - CIL. 91 MM
12702-2M-MLS - 1,15 - CIL. 91 MM
12702-3M-MLS - 1,20 - CIL. 91 MM
12702-3M-SC - 1,20 - CIL. 91 MM
JTA CABECOTE



12721 MLS
JTA COLETOR ESCAPE



12726 BO



12745 JGBO

VED. BICO VELAS



12746 BO

VED PARAFUSOS

12726 KTBO-KIT DE JTAS DA T V



12749 DI-DIAFRAGMA DA T V



12720 JGBO

JG JTA ADMISSÃO

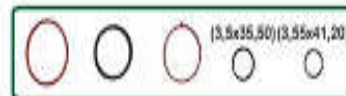

12705 KTBO

KIT VEDADORES MOTOR



12722 PAK-JTA DE ESCAPE

12726 KTBO-DI -KIT DE JTAS T V C/ DIAFRAGMA

JG JTA RETIFICAÇÃO



12733 PAK
JTA



12730 MLS
JUNTA DA
BOMBA
D'AGUA



12734 MLS
JTA



12741 PAK
JTA



12742 MLS
JTA



12743 MLS
JTA

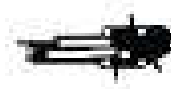

12737 MLS
JTA



12748 MLS
JTA



12747 PAK
JTA



12744 MLS
JTA



12727 NA



12728 NA
JTA DISTRIBUIÇÃO INTERNA



12716 MLS

XXXXX-KP
KIT PARAFUSOS DO CABEÇOTE

12705-KTRT OU 12705 KTRT-F (com ret flange tras.)
KIT DE RETENORES DO MOTOR

RET VALVULAS-07X12X19,5



1230083

FLANGE TRASEIRO



12705 FR

RET DIANT
50X90X8,5/13,5



1130283

2.5 8V 4C - FORD - RANGER 95/ - MTR MAXION TDI 310D - DIESEL

2.5 8V 4C - GM - S10 / BLAZER: 95/ - MTR MAXION TDI 310D - DIESEL

2.5 8V 4C - MB - SPRINTER 95/ - MTR MAXION TDI 310D - DIESEL

| | | | |
|------------|--|------------|---------------------------------------|
| 70106-JGCB | JG JTA MTR S/ CAB | 70106-JGRS | JG RETIF MTR S/ CAB |
| 70106-JGSC | JG JTA MTR C/ CAB DE FIBRA 3M | 70106-JGRV | JG RETIF MTR C/ CAB DE FIBRA 3M |
| 70106-JGML | JG JTA MTR C/ CAB DE CHAPA 3M | 70106-JGRM | JG RETIF MTR C/ CAB DE CHAPA 3M |
| 70106-JRSC | JG JTA MTR C/ CAB DE FIBRA 3M E C/ RET | 70106-JRRV | JG RETIF MTR C/ CAB DE FIBRA 3M E RET |
| 70106-JRML | JG JTA MTR C/ CAB DE CHAPA 3M E C/ RET | 70106-JRRM | JG RETIF MTR C/ CAB DE CHAPA 3M E RET |



70101 SC-1M - 1,35 MM - CIL. 92 MM
 70101 SC-2M - 1,45 MM - CIL. 92 MM
 70101 SC-3M - 1,60 MM - CIL. 92 MM
 70101 MLS-1M - 1,35 MM - CIL. 92 MM
 70101 MLS-2M - 1,45 MM - CIL. 92 MM
 70101 MLS-3M - 1,60 MM - CIL. 92 MM



70127 BO -- JTA TAMPA VÁLVULAS
 Nº ORIG: ERR2409



70244 BO - VEDADOR TAMPA VÁLVULAS



70120 F
 JTA COL ETOR ESCAPE
 Nº ORIG: ERR3785



70145 NA
 JTA BBA D AGUA



70144 NA
 JTA TERMOSTATO
 NºORIG:ERR3490



70142 NA
 JTA BBA D AGUA
 NºORIG:0002010880



70149 NA
 JTA FILTRO ÓLEO



70151 NA
 JTA BBA INJETORA

JG JTA RETIFICAÇÃO



70146 NA
 JTA TUBO INSPEÇÃO
 Nº ORIG: ERR1561



70148 NA
 JTA BBA VÁCUO
 Nº ORIG: ERR2027



70134 NA
 JTA



70135 NA
 JTA PAVIO VEDAÇÃO



10296 NA
 JTA BBA COMBÚSTIVEL
 Nº ORIG: ERR2028



70152 NA
 JTA RETENTOR TRASEIRO
 Nº ORIG: 0000110180



70141 NA
 JTA TAMPA DISTRIBUIÇÃO
 Nº ORIG: ERR4120



70140 NA
 JTA DISTRIBUIÇÃO INTERNA
 Nº ORIG: ERR4860



70115 NA / CB
 JTA CARTER

**70106-KP
 KIT PARAFUSOS DO CABEÇOTE**

**70106 KTRT OU 70106 KTRT-F (com flange)
 KIT DE RETENTORES DO MOTOR**

RET VALVULAS-08X12X11



1222396

FLANGE



70106 FR

RET CMD 46.7X62.3X09



1150009

RET DIANT

60,71X79,37X9,5



1150109

2.5 12V 4C - FORD - RANGER D / TD - MTR WLT - DIESEL

2.5 12V 4C - MAZDA - B2500 / MPV - MTR WLT - DIESEL

| | | | |
|------------|-------------------------------------|------------|------------------------------------|
| 12405-JGCB | JG JTA MTR S/ CAB | 12405-JGRS | JG RETIF MTR S/ CAB |
| 12405-JGSC | JG JTA MTR C/ CAB DE FIBRA | 12405-JGRV | JG RETIF MTR C/ CAB DE FIBRA |
| 12405-JGML | JG JTA MTR C/ CAB DE CHAPA | 12405-JGRM | JG RETIF MTR C/ CAB DE CHAPA |
| 12405-JRSC | JG JTA MTR C/ CAB DE FIBRA E C/ RET | 12405-JRRV | JG RETIF MTR C/ CAB DE FIBRA E RET |
| 12405-JRML | JG JTA MTR C/ CAB DE CHAPA E C/ RET | 12405-JRRM | JG RETIF MTR C/ CAB DE CHAPA E RET |



12404 SC / MLS
JTA CABEÇOTE



12426 BO
JTA TAMPA VÁLVULAS



12421 PAK / F
JTA COLETOR ESCAPE



12420 PAK
JTA ADMISSÃO



12463 PAK
GAXETA ESCAPE



12422 PAK
JTA ESCAPE

JG JTA RETIFICAÇÃO

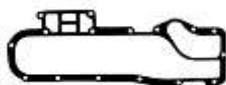

12434 NA
JTA TROCADOR CALOR

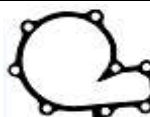

12430 NA
JTA BBA AGUA

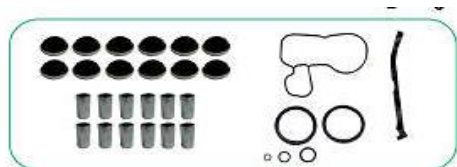

12405 KTBO
KIT VEDADORES MOTOR



12416 NA
JTA CARTER

12405-KP
KIT PARAFUSOS DO CABEÇOTE

12406-KTRT
KIT DE RETENTORES DO MOTOR

RET VALVULAS



1250112

RET GIRABREQUIM DIANT



RET COMANDO-32X46X07



1150050

RET GIRABREQUIM TRAS

90X110X09



1150296

2.5 16V 4C - RANGER / FUSION 13/ - MTR DURATEC-HE ECOBOOST - FLEX

| | | | |
|------------|-------------------------------------|------------|------------------------------------|
| 12210-JGCB | JG JTA MTR S/ CAB | 12210-JGRS | JG RETIF MTR S/ CAB |
| 12210-JGSC | JG JTA MTR C/ CAB DE FIBRA | 12210-JGRV | JG RETIF MTR C/ CAB DE FIBRA |
| 12210-JGML | JG JTA MTR C/ CAB DE CHAPA | 12210-JGRM | JG RETIF MTR C/ CAB DE CHAPA |
| 12210-JRSC | JG JTA MTR C/ CAB DE FIBRA E C/ RET | 12210-JRRV | JG RETIF MTR C/ CAB DE FIBRA E RET |
| 12210-JRML | JG JTA MTR C/ CAB DE CHAPA E C/ RET | 12210-JRRM | JG RETIF MTR C/ CAB DE CHAPA E RET |



12203 SC - 1,2 MM - CIL. 89 MM
12203 MLS - 0,5 MM - CIL. 89 MM
12203 MLS-2M - 1,5 MM - CIL. 89 MM
12203 MLS-3M - 2,0 MM - CIL. 89 MM
JTA CABEÇOTE



12285 BO

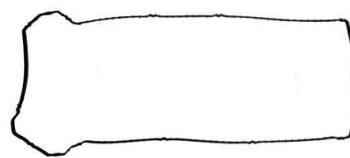

11527 JGBO-JTA TAMPA VÁLVULAS

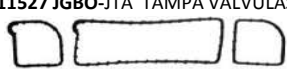

11546 KTBO-KIT BORR. VELA DA TV

11527 KTBO-KIT DE JTAS DA T V



12222 F
JTA DE ESCAPE



11155 NA
JTA CONEXÃO SAÍDA D AGUA



12221 F
JTA COLETOR ESCAPE
Nº ORIG: 1S7G9448AD



12220 JGBO
JG JTA ADMISSÃO
Nº ORIG: 1S7Z9439AA

JG JTA RETIFICAÇÃO



11153 NA
JTA SUPORTE FILTRO ÓLEO
Nº ORIG: 157Z6840AA



OR1-225
ANEL ORING
47,22 X 3,53 MM



11154 NA
JTA



OR1-210
ANEL ORING
19 X 3,53 MM



11158 NA
JTA VÁLVULA REGULADORA
VENTILAÇÃO MOTOR
Nº ORIG: 1S7Z9D476AA



12247 BO
ANEL DO BUJÃO
DO CARTER

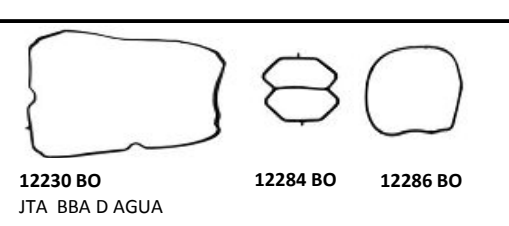

12230 BO
JTA BBA D AGUA

12284 BO 12286 BO

12207 KTBO

12207-KP
KIT PARAFUSOS DO CABEÇOTE

12207-KTRT OU 12207 KTRT-F (com ret flange tras.)
KIT DE RETENORES DO MOTOR

RET VALV-5,5X11X18,5



1230073

RETENTOR DIANT GIRABREQUIM
37X50X08



1130073

FLANGE TRASEIRO



12207 FR

2.5 24V V6 - MONDEO - MOTOR SEA GUIA - GAS

| | | | |
|------------|-------------------------------------|------------|------------------------------------|
| 12306-JGCB | JG JTA MTR S/ CAB | 12306-JGRS | JG RETIF MTR S/ CAB |
| 12306-JGML | JG JTA MTR C/ CAB DE CHAPA | 12306-JGRM | JG RETIF MTR C/ CAB DE CHAPA |
| 12306-JRML | JG JTA MTR C/ CAB DE CHAPA E C/ RET | 12306-JRRM | JG RETIF MTR C/ CAB DE CHAPA E RET |



12303/4 MLS - CIL. 91,5 MM
JTA CABEÇOTE

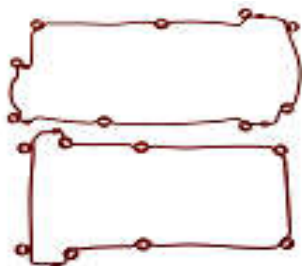

12326 BO
JTA TAMPÁ VÁLVULAS



12321 MLS / F
JTA COLETOR ESCAPE



12320 KTBO
JG JTAS ADMISSÃO



12319 NA
JG JTAS ADMISSÃO



12318 NA
JG JTAS ADMISSÃO

JG JTA RETIFICAÇÃO



12330 NA
JTA BBA AGUA

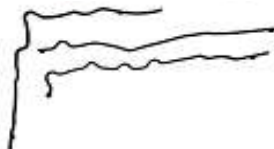

12306 KTBO
JG VEDADORES MOTOR



12316 BI

XXXXX-KP
KIT PARAFUSOS DO CABEÇOTE

12306-KTRT
KIT DE RETENORES DO MOTOR
RET VALV-5,5X12,3X18,5 RET COMANDO-47X63,5X8,5



Nº ORIG: 12025500



Nº ORIG: 15056500

RET GIRABREQUIM TRASEIRO-91X107,5X9,5



Nº ORIG: 15052700

2.6 8V 6C - FORD - MAVERICK - MTR E2600 - GAS

2.6 8V 6C - WILLYS - JEEP / RURAL / AERO - MTR E2600 - GAS

13306-JGCB JG JTA MTR S/ CAB

13306-JGRS JG RETIF MTR S/ CAB

13306-JGSC JG JTA MTR C/ CAB DE FIBRA

13306-JGRV JG RETIF MTR C/ CAB DE FIBRA



13301 SC - NORMAL
13301 FA - REVESTIDA DE FOLHA
13301 KT - CABEÇOTE BAIXO
13301 TB - TURBO
JTA CABEÇOTE
Nº ORIG: 801418N



13337 CB
JTA TAMPAS VALVULAS
Nº ORIG: 11492



13321 PAK
JTA COLETOR ESCAPE
Nº ORIG: 805592



10537 NA
JTA BASE CARBURADOR
Nº ORIG: B33796



13330 GV
JTA BBA D AGUA
Nº ORIG: 11485

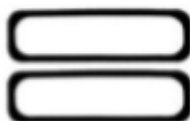

13326 CB
JTA TAMPAS LATERAIS VALVULAS

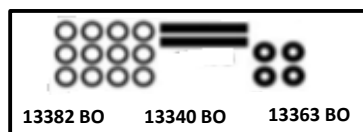

13306 KTBO

JG JTA RETIFICAÇÃO



10296 NA
JTA BBA COMBUSTÍVEL



13334 GV
JTA TAMPAS BBA ÓLEO
Nº ORIG: 29949



13331 GV
JTA BBA ÓLEO
Nº ORIG: 11484



13336 CB
JTA RESPIRO CARTER
Nº ORIG: 11478



13333 GV
JTA ENTRADA AGUA CABEÇOTE
Nº ORIG: 11487



13349 GV
JTA BBA ÓLEO



13347 GV
JTA BBA ÓLEO
Nº ORIG: DB4D6619A



13328 GV
JTA DIANTEIRA BLOCO



13327 CB
JTA DISTRIBUIÇÃO



13335 GV
JTA SUPORTE BBA ÓLEO



70019 A
GAXETA MANCAL
Nº ORIG: B24489



13316 CB
JTA CARTER
Nº ORIG: 11488

2.8 8V 4C - RANGER 02/ - MTR POWER STROKE TD - TURBO DIESEL

| | | | |
|------------|--|------------|---------------------------------------|
| 70107-JGCB | JG JTA MTR S/ CAB | 70107-JGRS | JG RETIF MTR S/ CAB |
| 70107-JGSC | JG JTA MTR C/ CAB DE FIBRA 3M | 70107-JGRV | JG RETIF MTR C/ CAB 3M DE FIBRA |
| 70107-JGML | JG JTA MTR C/ CAB DE CHAPA 3M | 70107-JGRM | JG RETIF MTR C/ CAB DE CHAPA 3M |
| 70107-JRSC | JG JTA MTR C/ CAB DE FIBRA 3M E C/ RET | 70107-JRRV | JG RETIF MTR C/ CAB DE FIBRA 3M E RET |
| 70107-JRML | JG JTA MTR C/ CAB DE CHAPA 3M E C/ RET | 70107-JRRM | JG RETIF MTR C/ CAB DE CHAPA 3M E RET |

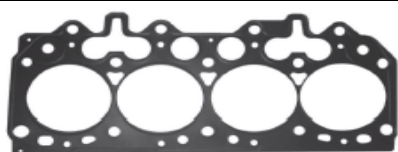

70127 BO -- JTA TAMPA VÁLVULAS
Nº ORIG: ERR2409



70120 F
JTA COL ETOR ESCAPE
Nº ORIG: ERR3785

- 70102 SC-1M - 1,35 MM - CIL. 94 MM
- 70102 SC-2M - 1,45 MM - CIL. 94 MM
- 70102 SC-3M - 1,60 MM - CIL. 94 MM
- 70102 MLS-1M - 1,35 MM - CIL. 94 MM
- 70102 MLS-2M - 1,45 MM - CIL. 94 MM
- 70102 MLS-3M - 1,60 MM - CIL. 94 MM



70244 BO - VEDADOR TAMPA VÁLVULAS



70145 NA
JTA BBA D AGUA



70144 NA
JTA TERMOSTATO



70142 NA
JTA BBA D AGUA



70149 NA
JTA FILTRO ÓLEO



70151 NA
JTA BBA INJETORA

JG JTA RETIFICAÇÃO



70146 NA
JTA TUBO INSPEÇÃO
Nº ORIG: ERR1561



70148 NA
JTA BBA VÁCUO
Nº ORIG: ERR2027



70134 NA
JTA



70135 NA
JTA



10296 NA
JTA BBA COMBÚSTIVEL
Nº ORIG: ERR2028



70146 NA
JTA TUBO INSPEÇÃO
Nº ORIG: ERR1561



70141 NA
JTA TAMPA DISTRIBUIÇÃO
Nº ORIG: ERR4120



70140 NA
JTA DISTRIBUIÇÃO INTERNA
Nº ORIG: ERR4860



70115 NA / CB
JTA CARTER

70106-KP KIT PARAFUSOS DO CABEÇOTE

70106 KTRT OU 70106 KTRT-F (com flange) KIT DE RETENORES DO MOTOR

RET VALVULAS-08X12X11



1222396

FLANGE



70106 FR

RET CMD 46.7X62.3X09



1150009

RET DIANT

60,71X79,37X9,5



1150109

3.0 12V V6 - RANGER / TAURUS / AEROSTAR - MTR OHV

| | | | |
|------------|-------------------------------------|------------|------------------------------------|
| 12106-JGCB | JG JTA MTR S/ CAB | 12106-JGRS | JG RETIF MTR S/ CAB |
| 12106-JGSC | JG JTA MTR C/ CAB DE FIBRA | 12106-JGRV | JG RETIF MTR C/ CAB DE FIBRA |
| 12106-JRSC | JG JTA MTR C/ CAB DE FIBRA E C/ RET | 12106-JRRV | JG RETIF MTR C/ CAB DE FIBRA E RET |



12103/4 SC - CIL. 91,5 MM
JTA CABEÇOTE

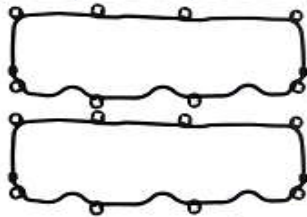

12126 JGBO
JTA DE TAMPA DE VÁLVULAS



12121 F
JTA DE COLETOR DE ESCAPE

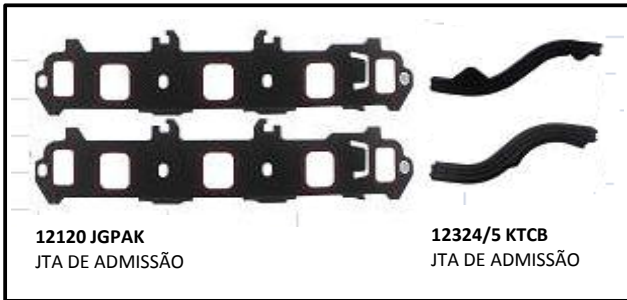

12120 JGPAK
JTA DE ADMISSÃO

12324/5 KTCB
JTA DE ADMISSÃO



12119 NA
JTA ADMISSÃO INTERNA



12132 NA
JTA TERMOSTATO

12120 KTPAK - JTA DE ADMISSÃO

JG JTA RETIFICAÇÃO



12130 NA
JTA DA BBA D'AGUA



12129 NA
JTA DA DISTRIBUIÇÃO



12116 BO

XXXXX-KP
KIT PARAFUSOS DO CABEÇOTE

12106-KTRT
KIT DE RETENTORES DO MOTOR

RET VALVULAS



RET GIRABREQUIM DIANT

47X65/80X15



RET GIRABREQUIM TRAS

88X108X10



1130249

3.0 16V 4C - RANGER FULL BR 05/ - MTR POWER STROKE INTERCOOLER - DIESEL

| | | | |
|------------|--|------------|---------------------------------------|
| 70105-JGCB | JG JTA MTR S/ CAB | 70105-JGRS | JG RETIF MTR S/ CAB |
| 70105-JGSC | JG JTA MTR C/ CAB DE FIBRA 3M | 70105-JGRV | JG RETIF MTR C/ CAB DE FIBRA 3M |
| 70105-JRSC | JG JTA MTR C/ CAB DE FIBRA 3M E C/ RET | 70105-JRRV | JG RETIF MTR C/ CAB DE FIBRA 3M E RET |

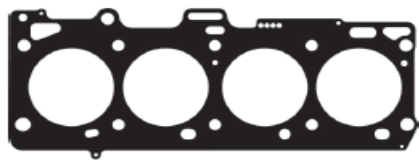

70104-1M-SC / MLS - 1,30MM
Nº ORIG: 70490793
70104-2M-SC / MLS - 1,50MM
Nº ORIG: 70490792
70104-3M-SC / MLS - 1,70MM
Nº ORIG: 70490791
JTA CABEÇOTE



70154 BO - JTA TAMPA DE VÁLVULAS



70146 BO
VEDADOR INJETOR



70145 BO
VEDADOR BICO VELA

70154 KTBO
JTA TAMPA VÁLVULAS C/ VEDADOR INJETOR



70118 F
JG JTA ADMISSÃO
Nº ORIG:



70121 F
JTA COLETOR ESCAPE
Nº ORIG: 70490785

JG JTA RETIFICAÇÃO



70158 BO
JTA ENTRA AGUA BLOCO
Nº ORIG: 70490708



70155 BO
JTA SUCCÃO ÓLEO
Nº ORIG: 70490709



70134 NA
JTA TROCADOR DE CALOR



70124 BO
JTA DISTRIBUIÇÃO



70157 NA
JTA FLANGE DIANTEIRO
Nº ORIG: 70490692



70159 BO
ANEL FECHAMENTO INJETORA
DISTRIBUIÇÃO Nº ORIG: 705901



70156 BO
JTA ENTRADA AGUA
Nº ORIG: 70490704



70133 BO
JUNTA DA BOMBA
DA AGUA



70133 NA
JTA DISTRIBUIÇÃO



70135 NA
JTA TUBULAÇÃO AGUA



70105 KTBO
KIT BORRACHAS



70160 BO
JTA ENTRADA
AGUA



70174 BO
JTA BBA INJETORA
Nº ORIG: 70490814



70105 KTAR
KIT ARRUELAS

70105-KP KIT PARAFUSOS DO CABEÇOTE

70105-KTRT KIT DE RETENTORES DO MOTOR

RET VALV-06X12X19,5



1230049

RET GIRABREQUIM DIANTEIRO

60.71X79.37X9,5



1150109

1150109

FLANGE TRASEIRA



70105 FR

3.2 20V 5C - FORD - FORD RANGER 13/ - MOTOR DURATORQ TDCI SAFA - DIESEL

3.2 20V 5C - FORD - TROLLER T4 - MOTOR DURATORQ TDCI SAFA - DIESEL

| | | | |
|------------|-------------------------------------|------------|------------------------------------|
| 12707-JGCB | JG JTA MTR S/ CAB | 12707-JGRS | JG RETIF MTR S/ CAB |
| 12707-JGSC | JG JTA MTR C/ CAB DE FIBRA | 12707-JGRV | JG RETIF MTR C/ CAB DE FIBRA |
| 12707-JGML | JG JTA MTR C/ CAB DE CHAPA | 12707-JGRM | JG RETIF MTR C/ CAB DE CHAPA |
| 12707-JRSC | JG JTA MTR C/ CAB DE FIBRA E C/ RET | 12707-JRRV | JG RETIF MTR C/ CAB DE FIBRA E RET |
| 12707-JRML | JG JTA MTR C/ CAB DE CHAPA E C/ RET | 12707-JRRM | JG RETIF MTR C/ CAB DE CHAPA E RET |



12703 MLS-1M - 1,10 MM - CIL. 91 MM
12703 MLS-2M - 1,15 MM - CIL. 91 MM
12703 MLS-3M - 1,20 MM - CIL. 91 MM
12703 SC-3M - 1,20 MM - CIL. 91 MM
JTA CABEÇOTE



12723 MLS - JTA COLETOR ESCAPE



12727 BO



12750 JGBO
JTA BICO VELAS



12751 JGBO
VED PARAFUSOS

12727 KTBO
JTA TAMPA VÁLVULAS



12719 JGBO
JG JTA ADMISSÃO

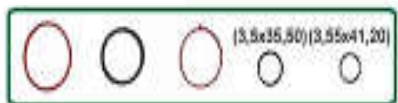

12705 KTBO
KIT VEDADORES MOTOR



12722 PAK - JTA DE ESCAPE

JG JTA RETIFICAÇÃO



12733 PAK
JTA



12730 MLS
JUNTA DA BOMBA D'AGUA



12734 MLS
JTA



12741 PAK
JTA



12742 MLS
JTA



12743 MLS
JTA



12737 MLS
JTA



12748 MLS
JTA



12747 BO
JUNTA DA TAMPA

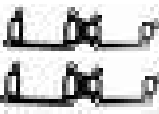

12744 MLS
JTA



12727 NA

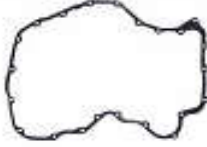

12728 NA
JTA DISTRIBUIÇÃO INTERNA



12717 MLS

XXXXX-KP
KIT PARAFUSOS DO CABEÇOTE

12707-KTRT OU 12707 KTRT-F (com ret flange tras.)
KIT DE RETENORES DO MOTOR

RET VALVULAS-07X12X19,5



1230083

FLANGE TRASEIRO



12705 FR

RET DIANT
50X90X8,5/13,5



1130283

3.6 12V 6C - F1000 / FALCON - GAS

| | | | |
|------------|-------------------------------------|------------|------------------------------------|
| 12006-JGCB | JG JTA MTR S/ CAB | 12006-JGRS | JG RETIF MTR S/ CAB |
| 12006-JGSC | JG JTA MTR C/ CAB DE FIBRA | 12006-JGRV | JG RETIF MTR C/ CAB DE FIBRA |
| 12006-JRSC | JG JTA MTR C/ CAB DE FIBRA E C/ RET | 12006-JRRV | JG RETIF MTR C/ CAB DE FIBRA E RET |



12601 SC
JTA CABEÇOTE
Nº ORIG: BAD3DZ6051A



12027 CB
JTA TAMPA VÁLVULAS
Nº ORIG: CODE6584B



11921 PAK
JTA COLETOR ESCAPE
Nº ORIG: BAC8DZ9448A



11924 PAK
JTA COLETOR ESCAPE



10334 PAK
GAXETA ESCAPE
NºORIG:C6AZ9450D

JG JTA RETIFICAÇÃO



11369 NA
JTA BASE
AQUECEDOR
Nº ORIG:



10169 NA
JTA BASE CARB.
Nº ORIG:
BAC9DZ9447B



43015 NA
JTA BBA COMB.
Nº ORIG:
C3AZ9417C



11365 NA
JTA BBA OLEO



48441 NA
JTA TUBO OLEO
Nº ORIG:
CODE6626A



10537 NA
JTA BASE CARB



61535 NA
JTA SAÍDA AGUA TERMOSTATO
Nº ORIG: CODE8255A



11367 NA
JTA BBA AGUA
Nº ORIG: CODE8507A



11368 NA
JTA DISTRIBUIÇÃO
Nº ORIG: BAC9DZ6020A



12016 CB
JG JTA CARTER
Nº ORIG: BAC9DZ6781A

XXXXX-KP KIT PARAFUSOS DO CABEÇOTE

12006-KTRT KIT DE RETENORES DO MOTOR

RET VALVULAS



1250191

RET GIRAB. DIANT 85,7X100,4X5,5



1151191

RET GIRAB TRAS. RET POLIA 85,7X102,6X9,7- 44,4X60,7X11



1150191



1152191

4.0 12V V6 - RANGER / EXPLORER 90/94 MTR 244 - GAS

11907-JGCB JG JTA MTR S/ CAB

11907-JGRS JG RETIF MTR S/ CAB

11907-JGSC JG JTA MTR C/ CAB DE FIBRA

11907-JGRV JG RETIF MTR C/ CAB DE FIBRA

11907-JRSC JG JTA MTR C/ CAB DE FIBRA E C/ RET

11907-JRRV JG RETIF MTR C/ CAB DE FIBRA E RET



11904/5 SC
JTA CABEÇOTE

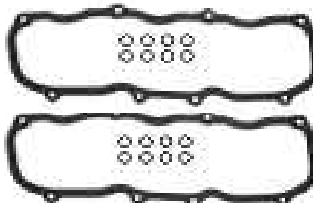

11926 CBLT
JTA DA TAMPA DA VÁLVULAS C/

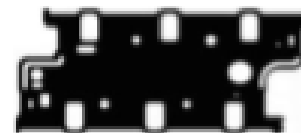

11920 PAK



12022 NA
JTA COLETOR ADMISSÃO
(FLAUTA)



11923 PAK
JTA COLETOR ESCAPE



11166 NA
JTA INJEÇÃO ELETRÔNICA
MULT POINT

JG JTA RETIFICAÇÃO



11933 NA
JTA ENTRADA ÓLEO



11071 NA
JTA ENTRADA ÓLEO



11932 NA
JTA BBA D AGUA



11928 NA
JTA DISTRIBUIÇÃO

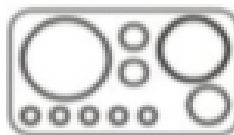

11906 KTBO
KIT VEDADORES MOTTOR



11918 BO

XXXXX-KP
KIT PARAFUSOS DO CABEÇOTE

11906-KTRT
KIT DE RETENORES DO MOTOR

RET VALVULAS-08X12X11



1222396

RETENOR DIANT GIRABREQUIM-RET GIRABREQUIM TRASEIRO

42X56X07

60,3X76,2X11,1



1130053



1130153

4.0 12V V6 - RANGER / EXPLORER / AEROSTAR 94/ MTR 244 - GAS

11906-JGCB JG JTA MTR S/ CAB

11906-JGRS JG RETIF MTR S/ CAB

11906-JGSC JG JTA MTR C/ CAB DE FIBRA

11906-JGRV JG RETIF MTR C/ CAB DE FIBRA

11906-JRSC JG JTA MTR C/ CAB DE FIBRA E C/ RET

11906-JRRV JG RETIF MTR C/ CAB DE FIBRA E RET



11904/5 SC - 1,4 MM - CIL. 102 MM
11904 KT - 2,7 MM - CIL. 102 MM
11905 KT - 2,7 MM - CIL. 102 MM
11904 TB - 1,9 MM - CIL. 102 MM
11905 TB - 1,9 MM - CIL. 102 MM
JTA CABEÇOTE

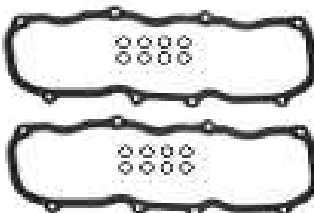

11926 CBLT
JTA DA TAMPA DA VÁLVULAS C/



11925 PAK
JTA CAPA ADMISSÃO



12022 NA
JTA COLETOR ADMISSÃO
(FLAUTA)

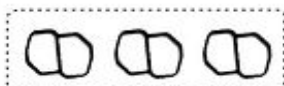

12023 JGBO
JG JTA ADMISSÃO (INJEÇÃO)



11923 PAK
JTA COLETOR ESCAPE



11166 NA
JTA INJEÇÃO ELETRÔNICA
MULT POINT

JG JTA RETIFICAÇÃO



11942 NA
JTA ENTRADA
ÓLEO



11943 NA
JTA SUÇÃO
ÓLEO



11944 NA
JTA BBA ÓLEO



11933 NA
JTA BBA D
AGUA



11071 NA
JTA ENTRADA
ÓLEO



11932 NA



11928 NA
JTA DISTRIBUIÇÃO

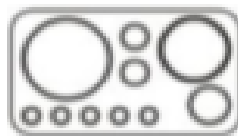

11906 KTBO
KIT VEDADORES MOTTOR



11917 CBBO

XXXXX-KP
KIT PARAFUSOS DO CABEÇOTE

11906-KTRT
KIT DE RETENORES DO MOTOR

RET VALVULAS-08X12X11

1222396

RETENTOR DIANT GIRABREQUIM-RET GIRABREQUIM TRASEIRO
42X56X07 60,3X76,2X11,1

1130053 1130153

4.8 16V V8 - F100 / F600 / GALAXIE - MTR 292 - GAS

11107-JGCB JG JTA MTR S/ CAB

11107-JGRS JG RETIF MTR S/ CAB

11107-JGSC JG JTA MTR C/ CAB DE FIBRA

11107-JGRV JG RETIF MTR C/ CAB DE FIBRA

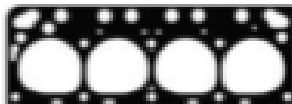

11020 SC
11020 CV
JTA DO CABEÇOTE



11864 CB
JTA CENTRAL VÁLVULAS



11911 BO
VEDADOR PARAFUSO TAMPA VÁLVULAS
Nº ORIG: 0001849380



11903 GV
JTA
TERMOSTATO



11863 CB - JUNTA DA TAMPA DE VÁLVULAS

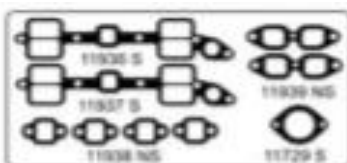

11935 PAK
JG JTA COLETOR ESCAPE
Nº ORIG: B7A9441B



11914 BO
VEDADOR HASTE DE VÁLVULAS



11729 PAK
JTA COLETOR ESCAPE
Nº ORIG: R5A9450A



11999 NA
JTA BASE CARBURADOR

JG JTA RETIFICAÇÃO



11939 NA
JTA BBA AGUA
Nº ORIG: B5A8507A



11570 GV
JTA BBA ÓLEO AO
BLOCO
Nº ORIG: B6Q6659A



11966 GV
JTA BBA
COMBUSTÍVEL
Nº ORIG: B5A9417A



10296 NA
JTA BBA
COMBUSTÍVEL



11907 NA
JTA TUBO TERMOSTATO
Nº ORIG: EAN8563B



11865 CB
JTA BASE
FILTRO
Nº ORIG:



261420
ANEL BUJÃO
CARTER
14,3 X 20 X 1,5



11660 CB
JTA VENTILADOR
CARTER
Nº ORIG:



QF 006
GAXETA
MANCAL
Nº ORIG:
B4A6710A



QF 047
GAXETA LAT
MANCAL
Nº ORIG:
EBU6348A

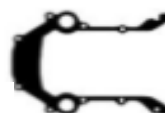

11898 NA
ITA DISTRIBUIÇÃO
Nº ORIG: B4A6020A



11860 CB
JTA CARTER

4.9 12V 6C - F1000 / F100 / F150 : 91/- - MTR 300 CID - GAS

| | | | |
|------------|-------------------------------------|------------|------------------------------------|
| 12606-JGCB | JG JTA MTR S/ CAB | 12606-JGRS | JG RETIF MTR S/ CAB |
| 12606-JGSC | JG JTA MTR C/ CAB DE FIBRA | 12606-JGRV | JG RETIF MTR C/ CAB DE FIBRA |
| 12606-JRSC | JG JTA MTR C/ CAB DE FIBRA E C/ RET | 12606-JRRV | JG RETIF MTR C/ CAB DE FIBRA E RET |



12602 SC



12626 CB



12621 PAK



12627 CB



12622 NA
JTA ADMISSÃO

JG JTA RETIFICAÇÃO



12630 NA
JTA BBA D'AGUA



12629 NA
JTA DISTRIBUIÇÃO



12644 NA
JTA



12616 BO



12633 NA
JTA



12634 NA
JTA



12636 NA
JTA



12643 NA
JTA

XXXXX-KP
KIT PARAFUSOS DO CABEÇOTE

12606-KTRT
KIT DE RETENORES DO MOTOR

RET VALVULAS

RET COMANDO-34X48X07



RET VIRABREQUIM DIANT.
36,5X50,5X07



RET VIRABREQUIM TRAS.
83X100X09



5.0 16V V8 - MAVERICK / GALAXIE / LANDAU : 1976 / 1978 - MTR 302 - GAS

11308-JGCB JG JTA MTR S/ CAB

11308-JGRS JG RETIF MTR S/ CAB

11308-JGSC JG JTA MTR C/ CAB DE FIBRA

11308-JGRV JG RETIF MTR C/ CAB DE FIBRA



11302 SC
11302-TB
JTA CABEÇOTE
Nº ORIG: D6DZ6051A

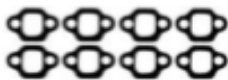

11719 PAK
JTA COLETOR ESCAPE

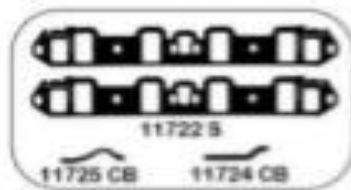

11721 PAK
JG JTA ADMISSÃO
Nº ORIG: D1AZ9433B

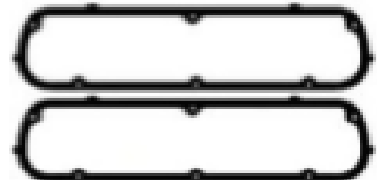

11726 CB
JTA TAMPA VÁLVULAS
NºORIG:C80Z6584A



11736 BO
VEDADOR HASTE VÁLVULAS

JG JTA RETIFICAÇÃO



11727 NA
JTA
DISTRIBUIÇÃO



11728 NA
JTA BBA D AGUA



11730 NA
JTA BBA

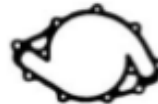

11731 NA
JTA BBA D
AGUA



10296 NA
JTA BBA



10720 NA
JTA
TERMOSTATO



11746 NA
JTA TUBO



11738 NA
JTA



11723 PP
JTA BBA ÓLEO



11737 NA
JTA VÁLVULA



11379 A
GAXETA
MANCAL

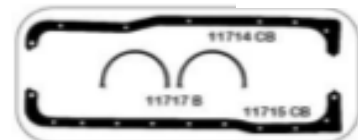

11716 CB
JG JTA CARTER
Nº ORIG: D00Z6781A

XXXXX-KP
KIT PARAFUSOS DO CABEÇOTE

CÂMBIOS



10376 PV 10500 NA 11147 PV 50183 PV 50185 PV 50188 PV 50189 PV

11140 PV Jogo para câmbio Clark CL 450- 5 marchas- caminhão VW 11.130 / 13.130 / Ford / GM / Dodge



10510 PV 10511 PV 10512 PV

11184 PV Jogo para câmbio Clark 260T - F-100 3M (61/76) alavanca na direção nacional sincronizado- orig. B8AZ -7153-A



10431 PV 10500 NA 10504 CB 10505 PV 11437 PV 11772 PV

11188 PV Jogo para câmbio ex. 240 F/FS Ford F.1 / F.6 / F-100 / F-350 / F-600 4M (importado sincronizado) orig. B894-7153-A



10197 G=PV 10431 PV 10500 NA 10505 PV 10512 PV 11437 PV

11189 PV Jogo para câmbio Clark α. 240 F/FS F-350 / F-600 (61/71) / 4 Marchas (nacional sincronizado) . ABT-7153-A



11241 PV 11242 PV

11191 PV N.Orig. BD2M-7153-A Jogo para câmbio- Corcel / Belina 4 marchas 1968 em diante



10510 PV 10511 PV 10512 PV

11192 PV N. Orig. BC7A-7153 Jogo para câmbio- Ford / Galaxie 1967 / 1976



10500 NA 10507 PV 10508 PV 10509 PV 11347 PV

11193 PV N. Orig. BCST -7153-C Jogo para câmbio F-600 Fuller seco 5 marchas

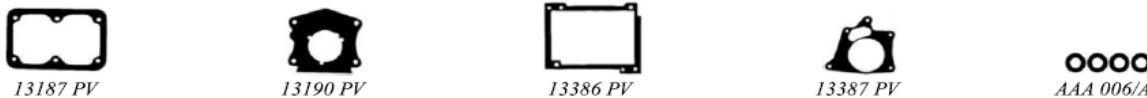

13187 PV 13190 PV 13386 PV 13387 PV AAA 006/A

11380 GV Jogo para câmbio WILLYS: JEEP / RURAL / AERO WILLYS / ITAMARATY / PICK UP WILLYS-FORD: MAVERICK 4 C / F100 / F75



11241 PV 11242 PV 11488 PV

11481 PV N.Original BE2M-7153-B Jogo p/câmbio Corcel II 1.6 / Del Rey / Pampa / Scala 4/5 marchas 68 ED

CÂMBIOS



10510 PV



10511 PV



10512 PV



10548 PV



10549 PV



11781 PV

11780 PV Jogo para câmbio Clark 260T – Maverick 8cc / Galaxie 4 marchas 1967 em diante



11882 NA



11883 NA



11885 NA



11886 CB



11887 PP



AAA 016/A



ORING 6765



ORING

11879 NA Jogo para câmbio Ford Ka / Fiesta / Focus / Eco Sport / Courier 96 em diante Cx. 1 B 5



11882 NA



11883 NA



11884 NA

11880 NA N. Orig. 84875/1 Jogo para câmbio Escort 4 marchas 1983 em diante



11662 NA



11882 NA



11883 NA



11884 NA

11881 NA N.Orig. 84875 Jogo para câmbio Escort 5 marchas 1983 em diante



13186 PV



13187 PV



13188 PV



13189 CB



13190 PV

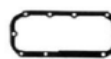

13191 NA



13386 PV



13387 PV



AAA 006/A

13680 PV N.Orig. 805295 / 644122-B. Jogo p/câmbio - Aero Willys / Jeep / Rural / Pick up tração 4 rodas 6cc c/ reduzida

CARBURADOR



11157 GV Jogo para carburador Holley- caminhão 8cc motor brasileiro- modelos F-100 / F-600- 58 / 66 – passeio 55 / 57



11489 GV



11490 GV



11491 GV



11999 NA



AAF 011/B



ORI 008

11160 GV Jogo para carburador Weber- F-100 / 350 / 600 / Galaxie 500 LTD 8 CC. 67 ED



10535 GV



10536 NA



11247 NA



AAF 006 / A



AAF 010

11162 GV Jogo para carburador DFV simples- Corcel II 1.4 / 1.6 / Del Rey / Pampa / Belina 72 ED



11167 GV

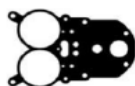

11342 GV



11393 NA











11395 NA











AAA 012

11350 GV Jogo para carburador Solex duplo- Corcel II 1.6 / Del Rey / Pampa









CARBURADOR

| | | | | | |
|---|---|---|---|---|---|
|  |  |  |  |  |  |
| 11352 NA | 11353 GV | 11352 GV | 11358 GV | 11356 GV | 11357 NA |
|  |  |  | | | |
| 11361 GV | 11362 FE | 11359 GV | | | |









11351 NA Jogo para carburador importada- Maverick 8 cc / Galaxie (anos todos)

| | | | | | | | |
|---|---|---|---|---|--|---|---|
|  |  |  |  |  |  |  |  |
| 10957 GV | 11868 NA | 11869 NA | 11745 NA | AAA 006/A | AAA 010 | ORI 005 | ORI 008 |

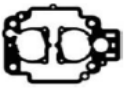



11850 GV Jogo para carburador DFV DUPLO - corcel / escort / del rey - CHT

| | | | | | | | |
|---|---|---|---|--|---|---|---|
|  |  |  |  |  |  |  |  |
| 11167 GV | 11869 NA | 11858 NA | 11853 NA | 46070 NA | ORI 005 | AAF 010 | AAA |

11851 GV Jg. p/carb. solex duplo BLFA - Monza 1.8/2.0 /Escort / Monza / Del Rey 1.8M / Gol / Santana 1.8/2.0 (âlc./gás.)





| | | | | |
|---|---|---|---|---|
|  |  |  |  |  |
| 11893 AB | 40668 GV | 46891 NA | 46892 GV | 46894 NA |
|  |  |  |  |  |
| 46895 GV | AAA 008/B | ORI 006 | ORI 009 | ORI 011 |

11870 GV Jogo para carburador Weber TLDR- Escort XR-3 / Del Rey / Pampa 1990 ED





| | | | | |
|---|---|---|---|---|
|  |  |  |  |  |
| 10535 GV | 10536 NA | 10537 NA | AAF 006/A | AAF 010 |

13350 GV N.Orig. 75BU-9510-B Jogo para carburador- Jeep / Rural / Pick up / F-75 1958/1962 6 cc.





JOGOS E REPAROS - INJEÇÃO ELETRÔNICA

| | | | |
|---|---|---|---|
|  |  |  |  |
| 11041 NA | 11042 NA | 11071 NA | ORI 203 |

11040 NA Reparo para I.E- Ford Ranger 2.3 / 2.5 M.P







| | | | | |
|---|---|---|--|---|
|  |  |  |  |  |
| 11041 NA | 11042 NA | 11071 NA | 11095 | ORI 203 |

SCKIT 11040 Reparo para I.E- Ford Ranger 2.3 / 2.5

| | | | | |
|---|---|---|---|---|
|  |  |  |  |  |
| 11042 NA | 11071 NA | 11072 NA | 11075 CB | ORI 203 |

11050 NA Jogo para I.E- Escort XR-3 / Royale / Versailles até 93 - Santana 2.0 - multipoint - sistema Bosch











JOGOS E REPAROS - INJEÇÃO ELETRÔNICA













| | | | | | | |
|--|---|---|---|--|---|---|
|  |  |  |  |  |  |  |
| 11042 NA | 11071 NA | 11072 NA | 11075 CB | 11095 | 46341 B | ORI 203 |
| SCKIT 11050 <i>Reparo para I.E- Escort XR-3 / Royale / Versailles até 93 - Santana 2.0- multipoint - sistema Bosch</i> | | | | | | |







| | | | |
|--|---|---|---|
|  |  |  |  |
| 11061 NA | 11062 NS | ORI 112 | ORI 123 |
| 11060 NA <i>Jogo para I.E- Fiesta 1.3 importado- sistema FIC EEC IV - c/ baquelite</i> | | | |







| | | | | |
|---|---|---|--|---|
|  |  |  |  |  |
| 11065 NA | 11071 NA | 11073 NA | 11074 NA | ORI 203 |
| 11070 NA <i>Jogo para I.E- Fiesta CLX</i> | | | | |







| | | | | | |
|---|---|---|---|---|---|
|  |  |  |  |  |  |
| 11065 NA | 11071 NA | 11073 NA | 11074 NA | 11095 | ORI 203 |
| SCKIT 11070 <i>Reparo para I.E.- Fiesta CLX</i> | | | | | |

| | | | | | |
|--|---|---|---|---|---|
|  |  |  |  |  | |
|  |  |  |  |  |  |
| 11081 NA | 11082 NA | 40051 GV | 46062 NA | 46071 NA | |
| 46072 NA | ORI 014 | ORI 018 | ORI 019 | ORI 2116 | SCBQ 1006 |
| 11080 NA <i>Jogo para I.E- Royale / Versailles - single Point - sistema Magnetti Marelli - s/ baquelite</i> | | | | | |
| 11080 NA-BQ <i>Jogo para I.E- Royale / Versailles - single Point - sistema Magnetti Marelli - c/ baquelite</i> | | | | | |















































| | | | | | |
|---|---|---|---|---|---|
|  |  |  |  |  |  |
|  |  |  |  |  |  |
| 11066 | 11081 NA | 11082 NA | 11084 | 46062 NA | 46071 NA |
| 46072 NA | ORI 014 | ORI 018 | ORI 019 | ORI 2116 | SCBQ 1006 |
| SCKIT 11080 <i>Reparo para I.E- Royale / Versailles - single oint - sistema Magnetti Marelli - c/ baquelite</i> | | | | | |

| | | | | | |
|---|---|---|---|---|---|
|  |  |  |  |  |  |
| 11093 FE | 11095 | 11096 B | 11097 B | 11098 B | 11099 B |
| 11088 B <i>Reparo para I.E- motor Zetec 1.8 16 V. - sistema FIC</i> | | | | | |





























| | | | | | |
|---|---|---|---|---|---|
|  |  |  |  |  |  |
| 11093 FE | 11094 B | 11095 | 11097 B | 11098 B | 11099 B |
| 11089 B <i>Reparo para I.E- Fiesta / Courier 1.4 / 16 V. - sistema FIC</i> | | | | | |

| | | | | | | |
|---|---|---|---|---|---|---|
|  |  |  |  |  |  |  |
| 11235 BO | 11092 B | 11093 FE | 11095 | 11098 B | 11099 B | ORI 203 |
| 11090 B <i>Reparo para I.E- Courier / Fiesta / Ka / motor endura- sistema FIC</i> | | | | | | |











JOGOS E REPAROS - INJEÇÃO ELETRÔNICA

| | | | | | |
|--|---|--|---|---|---|
|  |  |  |  |  | |
| 11043 NA | 11049 NA | 11071 NA | 11098 B | 11099 B | |
| 11150 NA Jogo para I.E.– Focus / Mondeo – Zetec 2.0 16 válvulas | | | | | |
|  |  |  |  |  |  |
| 11043 NA | 11049 NA | 11071 NA | 11095 | 11098 B | 11099 B |
| SCKIT 11150 Reparo para I.E.– Focus / Mondeo – Zetec 2.0 16 válvulas | | | | | |
|  |  |  |  |  | |
| 11041 NA | 11171 NA | 11172 NA | 11173 NA | ORI 203 | |
| 11170 NA Jogo para I.E.– Ford Ranger 4 cilindros importada | | | | | |
|  |  |  |  |  | |
| 11071 NA | 11165 NA | 11166 NA | 11166 NA | ORI 203 | |
| SCKIT 11170 Jogo para I.E.– Ford Ranger 4.0 L - 6 cilindros 94 à 01/97 | | | | | |
|  |  |  |  |  | |
| 11041 NA | 11042 NA | 11071 NA | 11186 NA | ORI 203 | |
| SCKIT 11180 Jogo para I.E.– Ranger 94/97 – motor Mazda DOHC 4cc 2300 L/Ranger 98 / mtr SOHC 4cc 2500 dupla | | | | | |
|  |  |  |  | | |
| 10432 NA | 11071 NA | 11187 NA | ORI 203 | | |
| SCKIT 11190 Jogo para I.E.– Ford Windstar 94- motor 3.8 L 6cc - EFI / MI | | | | | |
|  |  |  |  |  | |
| 11042 NA | 11071 NA | 11169 NA | 11098 B | ORI 203 | |
| SCKIT 11200 Jogo para I.E.– Ranger 94/95 ED – motor 6 cc (importada) | | | | | |
|  |  |  |  |  | |
| 11173 NA | 11281 NA | 11282 NA | 11283 NA | ORI 203 | |
| 11280 NA Jogo para I.E - F-1000 95/98 4.9L | | | | | |
|  |  |  |  |  |  |
| 11092 B | 11098 B | 11121 JGSI | 11335 SI | ORI 011 | ORI 203 |
| SCKIT 11640 Jogo para I.E.Zetec Rocam 1.0 I/ Ka 08/99 ed / Fiesta 96 ed/ Fiesta sedan 09/99 ed/ 1.0 I. aspirado 10/01 / Fiesta 03 ed 1.0 I. - aspirado 04/02 ed. | | | | | |









JOGOS E JUNTAS DE SAÍDA ESCAPE / CATALIZADOR

| | | | |
|--|--|--|---|
|  11023 PAK |  11420 JGBO |  11122 OR OU 11122 F |  11320 JGBO |
| JTA SAÍDA ESCAPE ZETEC 1.8 / 2.0 16V - MONDEO 2.0 97 ED | ANEL COL ADM ZETEC 1.4 | JTA COL ESC FORD ZETEC ROCAN | JG COL ADM ZETEC 1.8/2.0.16V |
|  11237 PAK |  11520 JGBO |  12220 JGBO |  11323 PAK |
| JTA SAÍDA ESC CORCEL II | JG ADM FOCUS/MONDEO | JG BORRACHA ADMISSÃO FOCUS | JTA COL ESCAPE F-75/ F100/ |
|  11137 PAK JG JTA COL ESC |  46622 F JG CATALISADOR |  11422 FA |  11127 PAK |
| KA/ FIESTA 1.0/1.3/ ENDURA | GOL/ ESCORT/ LOGUS | JTA CATALIZADOR - KA/FIESTA | JTA SAÍDA ESCAPE KA / FIESTA 1.0 / 1.3 |
|  11425 F OU 11425 OR |  11820 PAK OU 11820 F |  11121 JGBO |  11120 JGBO |
| JTA SAÍDA ESCAPE FIESTA | JTA CATALIZADOR ESCORT XR3/LOGUS/VERONA | JG ADMISSÃO - ZETEC ROCAM | JG BORRACHA ADMISSÃO SUPER CHARGER |
|  11719 PAK |  11721 PAK |  11729 PAK |  11837 PAK |
| JTA ESCAPE V8 - CANADENSE | JG ADMISSÃO MAVERICK /GALAXIE V8 IMPORTADO | JTA SAÍDA DO ESCAPE F100/ | JUNTA DO CATALIZADOR PARA FORD TODOS QUADRADA |
|  11822 FA/FF/PAK |  11935 PAK |  13121 PAK |  13021 PAK |
| JTA SAÍDA ESCAPE CHT 1.3/1.6/ GOL 1000 AE | JG TUBAGEM ESC/ADM V8 NACIONAL (9PÇS) | JG COL ESC JEEP 53/ 62 - HURRICANE | JTA ADMISSÃO ESCAPE JEEP 53/ |
|  13027 PAK |  13321 PAK JG ESC |  13322 PAK |  11578 BO |
| JTA SAÍDA ESCAPE WILLYS 6 CILS./ PUMA | MAV/WILLYS 6CC/ JEEP/PICK- | JTA TUBAGEM ADMISSÃO | VEDADOR CORPO BORBOLETA |







GAXETA DE ESCAPE

| | | | |
|--|--|--|--|
|  46035 PAK |  11034 PAK |  46939 PAK |  11963 PAK |
| GOL AE /BX / ESCORT /PARATI / SAVEIRO:TODOS-305253.12371 | ESCORT CHT ATÉ 86/VERONA | VERSAILLES/ROYALLE 1.8/2.0 (TODOS) 855253137 | RANGER 4 / 6 CILINDROS E9TZ/5E241/A |
|  71263 PAK |  11134 PAK |  11063 PAK |  11035 PAK |
| F-4000 (MWM) BEOC - 9451 | ESCORT/ FIESTA/ KA MOTOR | ESCORT/ FIESTA/ NOVO KA/N | ZETEC 1.8/2.0 16V-MONDEO IMPORTADO (TDS) 93BB9451CA |
|  11136 PAK |  71263 PAK |  71163 PAK |  11036 PAK |
| FIESTA | F4000 | F-1000 | FOCUS FLEX: 1.6 8V-1.8/2.0 16V 45 X 61 ,5 X 19 MM |



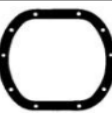
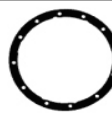

BAQUELITES

| | | | |
|---|---|---|---|
|  11344 BQ |  11062 BQ |  11658 BQ |  11272 BQ |
| BAQUELITE CARBURADOR SOLEX DUPLO CORCEL II | JTA CALÇO INJEÇÃO ELET. | JTA CARB. SOLEX SIMPLES | JTA CALÇO BOMBA GASOLINA CORCEL |
|  11345 BQ |  11868 BQ |  11869 BQ |  10968 BQ |
| BAQUELITE CARBURADOR MAV 4C/CORCEL: WEBER DUP | JTA CALÇO CARBURADOR WEBER | JTA CALÇO INFERIOR | JTA CALÇO CARB. CHEVETTE DUPLO MINI PROGRESSIVO |
|  11867 BQ | | | |
| CALÇO DISTANCIADOR | | | |





DIVERSAS





| | | | |
|---|---|---|---|
|  11346 GV |  11642 GV |  11654 NA |  11931 NA |
| JTA RODA LIVRE PAMPA | JTA SEMI-EIXO F350 / F4000 - | JTA DIFERENCIAL PAMPA 4 X 4 | JTA DIFERENCIAL F350 (55/67) B5Y4035A |
|  13346 GV |  13348 GV |  10518 NA |  13362 GV |
| JTA RODA LIVRE WILLYS: JEEP / RURAL / F75 - B16691 | JTA SEMI-EIXO F2000 / AGRALE | JTA DIF WILLYS 6C-37671 | JTA SEMI-EIXO F75 / JEEP / F100 / GALAXIE-B18691 |





DIVERSAS





| | | | |
|---|---|---|---|
|  |  |  |  |
| 11216 BI | 11059 BO | 11063 NA | 11517 NA |
| JTA CÂRTER (ALUMÍNIO) KA/ | JTA BORRACHA ARANHA ROCAM | JTA INJEÇÃO ELETRÔNICA FORD | JTA CÂRTER INFERIOR FOCUS 1.8/ 2.0 16 V ÁLVULAS |

| | | | |
|---|---|--|---|
|  |  |  |  |
| 11064 AL | 11087 BO | 11135 BO | OR1-229 OU 11644 BO |
| JTA INJEÇÃO ELETRÔNICA GOL 1000 MI (ALUMÍNIO) | ANEL VÁLV. TERMOSTÁTICA ZETEC ROCAM/ FIESTA 2003 ED. W/703273/53/00 | JTA GUARNIÇÃO FLANGE BBA. GOL/PARATI/LOGUS/POINTER/SA VEIRO/ESCORT/VERONA 377919133B | ANEL BÓIA COMB:CORCEL/ DELREY/PAMPA 78 ED/ F-100/F-1000 COAF9276A |





| | | | |
|---|---|---|---|
|  |  |  |  |
| 11138 BO | 11267 CB | 11149 BO | 11174 NA |
| JTA VEDADOR BOCA TAMQUE CORCEL II | JTA BÓIA TAMQUE F2000/ F4000/ WILLYS/ CORCEL | JTA GUARNIÇÃO BOMBA | JTA INJEÇÃO - TBI F-250 (GÁS) F7529E936AA |

| | | | |
|---|---|---|---|
|  |  |  |  |
| 12602 SC | 11632 CB JTA BORRACHA BOCAL | 11363 NA | 11364 NA |
| JTA CABEÇOTE F-1000 4.9 | ÓLEO CORCEL II - 7057030 | JTA BASE CARBURADOR | JTA BASE CARBURADOR |

| | | | |
|---|---|---|---|
|  |  |  |  |
| 11736 BO | 11844 BO | 46723 FA | 11911 BO |
| VEDADOR DA HASTE DE VÁLVULAS - MAVERICK/ LANDAU V8 302 - IMPORTADO | VEDADOR DO FILTRO DE AR DO MOTOR CHT | BAQUELITE CARBURADOR CHT - OSSO | VEDADOR (selo) TAMPA F100/F350/F600 MOTOR NACIONAL-B4A6570A |





| | | | |
|---|---|---|---|
|  |  |  |  |
| 11914 BO | 11924 PAK | 13338 BO | 13363 BO |
| VEDADOR (chapéu) VÁLV. F100/ F350/F600/C-10 /MBB adaptado B5A6571A | JTA TUBAGEM ADMISSÃO F-1000 6 CILINDROS 3.6 | JTA BOMBA GASOLINA WILLYS / JEEP | JTA BORR. PARAFUSOS VÁLV. WILLYS / F-75 / F-100 |



GAXETA DE ESCAPE



| | | | |
|---|---|---|---|
|  |  |  |  |
| 13382 BO | 11635 BC | 11337 BO | 11267 CB |
| VEDADOR VÁLVULAS WILLYS | JG BORRACHAS TAMPA VÁLV. | JOGO GAXETA F-100/ MAVERICK 4 | JUNTA DA BÓIA DO TANQUE |

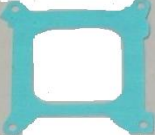

DIVERSAS

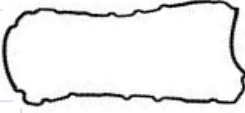
| | | | |
|---|---|--|---|
|  |  |  |  |
| 11337 BO | 11422 PAK | 11452 BO | 11646 BO |
| GAX MANCAL TRASEIRO - MAVERICK/RURAL 4CC - | JUNTA DA ADMISSÃO DO | ANEL OITO MOTOR ENDURA 1.0/1.3 8V | VEDADOR DO RESERV DE AGUA CORCEL I / II - BELINA - |

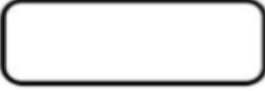

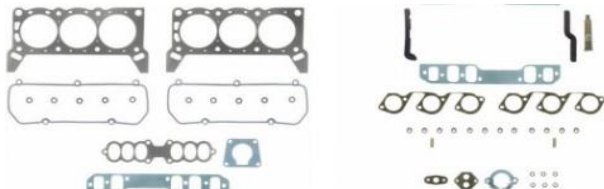



| | | | |
|---|---|---|---|
|  |  |  |  |
| 11647 FI | 11718 BO | 11732 CB | 11750 GV |
| ARRUELA DO BUJÃO DO CARTER CORCELII - | MEIA LUA DO CARTER DO MAVERICK / GALAXIE : V8 - | VEDADOR DA TAMPA DA BOMBA DE ÓLEO-MAVERICK / GALAXIE - 302 V8 | JUNTA DA BASE DO CARBURADOR QUADRIJET 4 F |

| | | |
|---|---|--|
|  |  |  |
| 11750 NA | 11751 GV | 11118 BO |
| JUNTA DA BASE DO CARBURADOR QUADRIJET 4 F | JUNTA DA BASE DO CARBURADOR QUADRIJET 8 F | JUNTA DO CARTER DA RANGER 4.0 V6 12V 90/94 - |

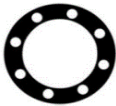
| | | |
|---|---|--|
|  |  | 11309-JRRV JOGO DE JUNTA DO MOTOR DO MUSTANG 3.8 V8 |
| 11226 KTBO | |  |
| KIT DE BORRACHAS DA TAMPA DE VÁLVULAS - CORCEL I / II - CLIO 1.6 | | |

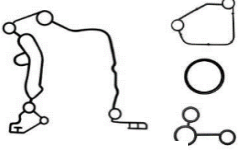
| | | |
|---|---|--|
|  |  |  |
| 11816 JGBO | 12403 MLS | 12406 JRML |
| JOGO DE MEIA LUA DO CARTER CHT - PAR | JUNTA DO CABEÇOTE F250 4.2 12V V6 99/ | JOGO DE JUNTAS DO MOTOR F250 4.2 12V V6 99/ |

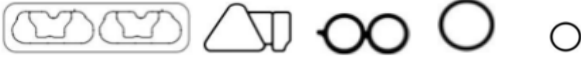
DIVERSAS

| | | | |
|--|---|---|--|
|  <p>11842 NA</p> |  <p>13388 BO</p> |  <p>13393 NA</p> |  <p>70124 KTBO</p> |
| <p>JUNTA DO CUBO F 12000 SAPAO/VW/GM: 77/ TRASEIRO</p> | <p>VEDACAO DO FILTRO OLEO WILLYS 4/6 CILS</p> | <p>JUNTA DA BASE DO CARBURADOR DFV DO WILLYS 6 C</p> | <p>KIT DE JUNTAS DA DISTRIBUIÇÃO DE ÓLEO RANGER 3.0 16V DISTRIB 05/</p> |
| <p>JOGO DE JUNTAS DO MOTOR DO TAURUS 3.0 24V V6</p>  <p>12109 JRML</p> |  <p>11004 KTBO</p> <p>JOGO DE BORRACHAS DO MOTOR ROCAN: 1.0/1.6 8V</p> | | |
|  <p>12503 MLS</p> | | | |
| <p>JUNTA DO CABEÇOTE ECOSPORT 17/ KA/KA+ 18/ 1.5 12V 3C -</p> | | | |