

1.0/1.3 8V 4C - FIAT 1050/1300 - FIAT 147 / OGGI / PANORAMA / UNO / PRÊMIO / ELBA / SPAZIO : 76/88 - GAS

40306-JGCB	JG JTA MTR S/ CAB	40306-JGRS	JG RETIF MTR S/ CAB
40306-JGSC	JG JTA MTR C/ CAB DE FIBRA	40306-JGRV	JG RETIF MTR C/ CAB DE FIBRA
40306-JRSC	JG JTA MTR C/ CAB DE FIBRA E C/ RET	40306-JRRV	JG RETIF MTR C/ CAB DE FIBRA E RET



40301 SC - 1,8 MM - CIL. 77 MM
40301 KT - 2,8 MM - CIL. 77 MM
40301 TB - 2,3 MM - CIL. 77 MM
JTA CABEÇOTE



40326 CB
JTA TAMPA DE VÁLVULAS



40321 PAK
JTA COL ESC



40322 PAK
JTA SAÍDA ESCAPE



40341 GV
FLANGE ENTRADA BOMBA D'AGUA



40337 NA
40337 GV
40337 PAK
JTA CORPO BOMBA



40336 NA
JTA DO



40339 NA
JTA TUBULAÇÃO



40342 GV
JTA DO



40335 NA
JTA BASE

JG JTA RETIFICAÇÃO



40340 NA
JTA TPA TRASEIRA



40338 NA
JTA TAMPA DIANTEIRA



40331 GV
JTA CORPO BOMBA D'AGUA



40348 NA
JTA DO RESPIRO



40343 NA
JTA BOMBA



40344 NA
JTA BOMBA COMBUSTÍVEL



40330 NA
JTA BOMBA COMBUSTÍVEL



40333 NA
JTA TAMPA DIANTEIRA



40334 NA
JTA TAMPA TRASEIRA BLOCO



40347 NA
JTA TAMPA GIRABREQUIM



40349 NA
JTA TAMPA DIANTEIRA



40345 NA
JTA BASE DO DISTRIBUIDOR



40328 GV
JTA TPA DISTRIBUIÇÃO



40329 GV
JTA CARÇAÇA DISTRIBUIÇÃO



40538 PP
JTA BOMBA



40332 PP
JTA CORPO



40536 PP
JUNTA

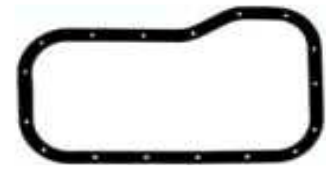

40316 CB
JTA CARTER

40306-KP

KIT PARAFUSOS DO CABEÇOTE

40307-KTRT

KIT DE RETENORES DO MOTOR

RET VALVULAS-08X11X10



1212544

RET VIRABREQUIM DIANT

40X56X07



1142005

RET COMANDO-30X52X07



1142006

RET VIRABREQUIM TRAS

70X85X08



1142269

1.0/1.3/1.5 8V 4C - UNO / MILLE / PREMIO: 1.0 8V - UNO / FIORINO: 1.3 8V - UNO / ELBA: 1.5 8V : 88/95 - MTR FIASA

40307-JGCB	JG JTA MTR S/ CAB	40307-JGRS	JG RETIF MTR S/ CAB
40307-JGSC	JG JTA MTR C/ CAB DE FIBRA	40307-JGRV	JG RETIF MTR C/ CAB DE FIBRA
40307-JRSC	JG JTA MTR C/ CAB DE FIBRA E C/ RET	40307-JRRV	JG RETIF MTR C/ CAB DE FIBRA E RET

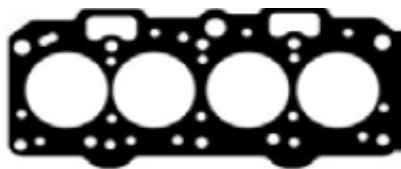

40302 SC - 1,9 MM - CIL. 77 MM
40302 KT - 2,9 MM - CIL. 77 MM
40302 TB - 2,4 MM - CIL. 77 MM

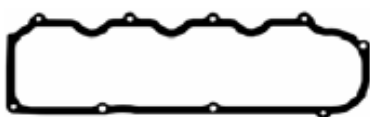

40426 GV / PH / PV
JTA TPA VLV



40321 PAK
JTA COL ESC
Nº ORIG: XXXX



40336 NA



40339 NA
JTA TUBULAÇÃO
DÁGUA



40342 GV
JTA
TERMOSTATO



40341 NA
FLANGE BBA



40337 NA
JTA CORPO
BBA DÁGUA



40335 NA
JTA



40322 PAK
JTA ESCAPE
NºORIG:XXXX

JG JTA RETIFICAÇÃO



40348 NA
JTA DO
RESPIRO



40330 NA
JTA BBA
COMBUSTÍVEL



40331 GV
JTA BBA
DÁGUA



40338 NA
JTA TPA
DIANT.



40340 NA
JTA TPA
TRASEIRA



40332 PP
JTA BBA
ÓLEO



40328 GV
JTA TPA



40329 GV
JTA CARÇAÇA
DISTRIBUIÇÃO



40343 NA
JTA BBA
COMBUSTIVEL



40344 NA
JTA BBA



40345 NA
JTA BASE
CARBURADOR

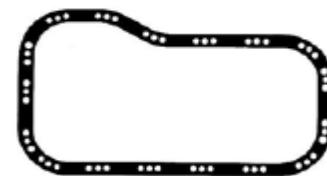

40317 CB
40317 NA
JTA CARTER



40347 NA
JTA TPA
GIRABREQUIM



40349 NA
JTA TPA
DIANTEIRA



40333 NA
JTA TPA
DIANTEIRA



40334 NA
JTA TPA TRASEIRA



40536 PP
JTA DIV



40238 PP
JTA BBA

40409-KP KIT PARAFUSOS DO CABEÇOTE

40307-KTRT KIT DE RETENTORES DO MOTOR

RET VALVULAS-08X11X10



1212544

RET VIRABREQUIM DIANT

40X56X07



1142005

RET COMANDO-30X52X07



1142006

RET VIRABREQUIM TRAS

70X85X08



1142269

1.0/1.5 8V 4C - PALIO / MILE / SIENA 1.0 8V - PALIO / FIORINO / SIENA / STRADA 1.5 8V: 96/01 - MPI

40409-JGCB	JG JTA MTR S/ CAB	40409-JGRS	JG RETIF MTR S/ CAB
40409-JGSC	JG JTA MTR C/ CAB DE FIBRA	40409-JGRV	JG RETIF MTR C/ CAB DE FIBRA
40409-JRSC	JG JTA MTR C/ CAB DE FIBRA E C/ RET	40409-JRRV	JG RETIF MTR C/ CAB DE FIBRA E RET

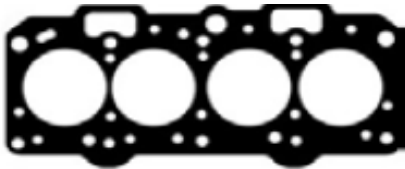

40302 SC - 1,9 MM - CIL. 77 MM
40302 KT - 2,9 MM - CIL. 77 MM
40302 TB - 2,4 MM - CIL. 77 MM



40422 NA
JTA ADMISSÃO



40337 PAK
JTA ESCAPE

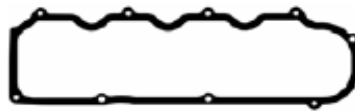

40426 NA
40426 GV



40421 PAK
JTA COL ETOR
ESCAPE



40449 NA
JTA INJEÇÃO
ELETRÔNICA



40447 NA
JTA BBA



40336 NA
JTA COMANDO



40339 NA
JTA TUBULAÇÃO
DÁGUA



40448 NA
JTA TPA TRASEIRA
AO CABEÇOTE

JG JTA RETIFICAÇÃO



40341 GV
FLANGE BBA



40338 NA
JTA TPA
DIANTEIRA



40331 GV
JTA BBA



40537 NA
JTA DO RESPIRO



40340 NA
JTA TPA



40333 NA
JTA TPA
DIANTEIRA



40334 NA
JTA TPA
TRASEIRA AO



40347 NA
JTA TPA
GIRABREQUIM



40434 NA
JTA TPA
DIANTEIRA



40459 NA
JTA TPA TRASEIRA



40328 GV
JTA TPA



40329 GV
JTA CARÇAÇA
DISTRIBUIÇÃO



40332 NA
JTA BBA



40536 PP
JTA DIV



40238 PP
JTA BBA ÓLEO



40816 CBLT
JTA CARTER

40409-KP

KIT PARAFUSOS DO CABEÇOTE

40307-KTRT

KIT DE RETENORES DO MOTOR

RET VALVULAS-08X11X10



1212544

RET VIRABREQUIM DIANT

40X56X07



1142005

RET COMANDO-30X52X07



1142006

RET VIRABREQUIM TRAS

70X85X08



1142269

1.0/1.3 8V 4C - UNO / PALIO / SIENA : 01/ - MTR FIRE E FIRE FLEX

40105-JGCB	JG JTA MTR S/ CAB	40105-JGRS	JG RETIF MTR S/ CAB
40105-JGSC	JG JTA MTR C/ CAB DE FIBRA	40105-JGRV	JG RETIF MTR C/ CAB DE FIBRA
40105-JGML	JG JTA MTR C/ CAB DE CHAPA	40105-JGRM	JG RETIF MTR C/ CAB DE CHAPA
40105-JRSC	JG JTA MTR C/ CAB DE FIBRA E C/ RET	40105-JRRV	JG RETIF MTR C/ CAB DE FIBRA E RET
40105-JRML	JG JTA MTR C/ CAB DE CHAPA E C/ RET	40105-JRRM	JG RETIF MTR C/ CAB DE CHAPA E RET

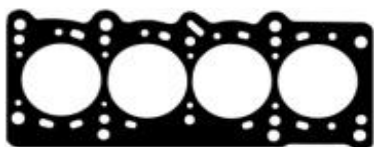

40101 SC - 1,2 MM - CIL. 71,5 MM
 40101 MLS - 0,5 MM - CIL. 71,5 MM
 40101 MLS-3M - 1,5 MM - CIL. 71,5 MM
 40101 KT - 2,2 MM - CIL. 71,5 MM



40022 JGBO
 JTAS ADMISSÃO



40622 PAK
 JTA ESCAPE



40048 NA
 JTA
 TERMOSTATO

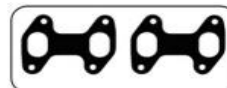

40024 PAK
 JTAS COLETOR ESCAPE



40718 BO
 JTA SENSOR
 TEMPERATURA

JG JTA RETIFICAÇÃO



40149 NA
 JTA DISTRIBUIÇÃO/
 BBA ÓLEO

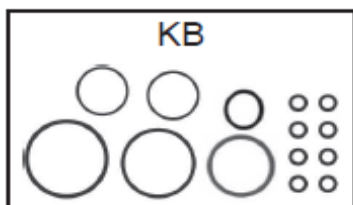

40180 KTBO
 KIT DE BORRACHAS MOTOR



40132 NA
 JTA BOMBA D'ÁGUA



40117 BO
 40117 CB
 JTA CARTER

40105-KP
 KIT PARAFUSOS DO CABEÇOTE

40105-KTRT 40105 KTRT-F (com ret flange tras.)
 KIT DE RETENORES DO MOTOR

RET VALVULAS-07X10X10



1213044

RET CMD-30X42X07



1145093

RET GIRABREQUIM DIANT-
 27X37X07



1140049

FLANGE TRASEIRA



40105 F

1.0/1.3 8V 4C - PALIO / SIENA / STRADA / UNO / FIORINO : 05/ - MTR FIRE FLEX 188A4000

40108-JGCB	JG JTA MTR S/ CAB	40108-JGRS	JG RETIF MTR S/ CAB
40108-JGSC	JG JTA MTR C/ CAB DE FIBRA	40108-JGRV	JG RETIF MTR C/ CAB DE FIBRA
40108-JGML	JG JTA MTR C/ CAB DE CHAPA	40108-JGRM	JG RETIF MTR C/ CAB DE CHAPA
40108-JRSC	JG JTA MTR C/ CAB DE FIBRA E C/ RET	40108-JRRV	JG RETIF MTR C/ CAB DE FIBRA E RET
40108-JRML	JG JTA MTR C/ CAB DE CHAPA E C/ RET	40108-JRRM	JG RETIF MTR C/ CAB DE CHAPA E RET



40101 SC - 1,2 MM - CIL. 71,5 MM
 40101 MLS - 0,5 MM - CIL. 71,5 MM
 40101 MLS-3M - 1,5 MM - CIL. 71,5 MM
 40101 KT - 2,2 MM - CIL. 71,5 MM



40826 BO
 JTA TAMPA DE VÁLVULAS



40024 PAK

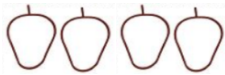

40019 JGBO
 JTA ADMISSÃO



40622 GV
 JTA ESCAPE



40048 NA
 JTA
 TERMOSTATO



40718 BO
 JTA SENSOR
 TEMPERATURA

JG JTA RETIFICAÇÃO



40149 NA
 JTA DISTRIBUIÇÃO/
 BBA ÓLEO



40132 NA
 JTA BOMBA D'ÁGUA

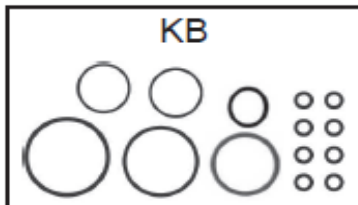

40180 KTBO
 KIT DE BORRACHAS



40117 BO/CB / CBBO
 JTA CARTER

40105-KP
 KIT PARAFUSOS DO CABEÇOTE

40105-KTRT 40105 KTRT-F (com ret flange tras.)
 KIT DE RETENORES DO MOTOR

RET VALVULAS-07X10X10



1213044

RET CMD-30X42X07



1145093

RET GIRABREQUIM DIANT-
 27X37X07



1140049

FLANGE TRASEIRA



40105 F

1.0 8V 4C - UNO / PALIO / SIENA / MOBI : 09/ - MTR EVO FLEX

1.4 8V 4C - PALIO / UNO / GRAND SIENA / PUNTO / 500 / IDEA : 09/ - MTR EVO FLEX

40107-JGCB	JG JTA MTR S/ CAB	40107-JGRS	JG RETIF MTR S/ CAB
40107-JGSC	JG JTA MTR C/ CAB DE FIBRA	40107-JGRV	JG RETIF MTR C/ CAB DE FIBRA
40107-JGML	JG JTA MTR C/ CAB DE CHAPA	40107-JGRM	JG RETIF MTR C/ CAB DE CHAPA
40107-JRSC	JG JTA MTR C/ CAB DE FIBRA E C/ RET	40107-JRRV	JG RETIF MTR C/ CAB DE FIBRA E RET
40107-JRML	JG JTA MTR C/ CAB DE CHAPA E C/ RET	40107-JRRM	JG RETIF MTR C/ CAB DE CHAPA E RET



40103 SC - 1,2 MM - 72,5 MM
40103 MLS - 0,5 MM - 72,5 MM
40103 MLS-2M - 1,0 MM - CIL. 72,5 MM
40103 KT - 2,2 MM - CIL. 72,5 MM

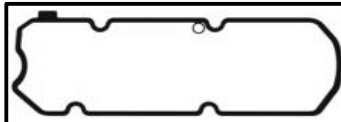

40825 BO -JTA TAMPAS VÁLVULAS

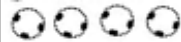

40845 BO -VEDADORES DA T V

40825 KTBO -KIT DE JUNTAS DA



40024 PAK/FF
JTAS COLETOR ESCAPE



40048 NA
JTA
TERMOSTATO



40119 KTBO
JG JTA ADMISSÃO



40118 JGBO
JG JTA ADMISSÃO



46078 BO
ANEL CORPO DE
BORBOLETA



OR1 203
ANEL DO BICO INJ.
7,52X3,53mm



OR2 016
ANEL BORRACHA



40718 BO
JTA SENSOR

JG JTA RETIFICAÇÃO



40169 NA
JTA DISTRIBUIÇÃO /
BBA ÓLEO



40167 NA
JUNTA



40132 NA
JTA BOMBA DÁGUA

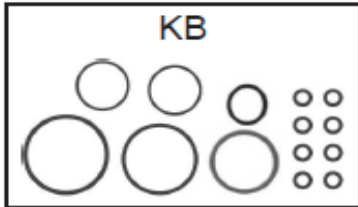

40180 KTBO KIT VEDADORES MOTOR



40149 NA
JTA DISTRIBUIÇÃO /
BBA ÓLEO



40120 PAK
40120 CB

40105-KP
KIT PARAFUSOS DO CABEÇOTE

40107-KTRT 40107 KTRT-F (com ret flange tras.)
KIT DE RETENORES DO MOTOR

RET VALVULAS-05X08X08



1240079

RET CMD-31X55X07



1145808

RET GIRABREQUIM DIANT-
27X37X07



1140049

FLANGE TRASEIRA



40106 FR

1.0/1.3 16V 4C - PALIO / SIENA / DOBLO : 00/ - GAS E FLEX - MTR FIRE

40106-JGCB	JG JTA MTR S/ CAB	40106-JGRS	JG RETIF MTR S/ CAB
40106-JGSC	JG JTA MTR C/ CAB DE FIBRA	40106-JGRV	JG RETIF MTR C/ CAB DE FIBRA
40106-JGML	JG JTA MTR C/ CAB DE CHAPA	40106-JGRM	JG RETIF MTR C/ CAB DE CHAPA
40106-JRSC	JG JTA MTR C/ CAB DE FIBRA E C/ RET	40106-JRRV	JG RETIF MTR C/ CAB DE FIBRA E RET
40106-JRML	JG JTA MTR C/ CAB DE CHAPA E C/ RET	40106-JRRM	JG RETIF MTR C/ CAB DE CHAPA E RET

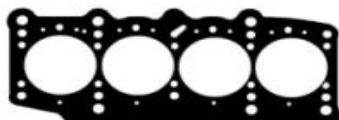

40102 SC - 1,2 MM - CIL. 71,5 MM
 40102 MLS - 0,5 MM - CIL. 71,5 MM
 40102 MLS-3M - 1,5 MM - CIL. 71,5 MM
 40102 KT - 2,2 MM - CIL. 71,5 MM

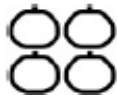

40023 JGBO



40126 CV
 40126 NA
 JTA TAMPA DE VÁLVULAS



40167 NA
 JUNTA TAMPA LATERAL



40048 NA
 JTA TERMOSTATO



40124 PAK



40168 PAK
 40168 F
 JTA SAÍDA ESCAPE

JG JTA RETIFICAÇÃO



40132 NA
 JTA BOMBA D'ÁGUA



40169 NA
 JTA DISTRIBUIÇÃO /
 BBA ÓLEO



40181 KTBO
 KIT VEDADORES MOTOR

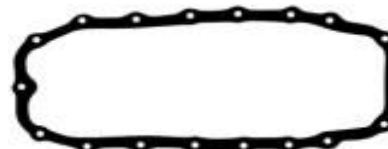

40120 PAK
 40120 CB
 JTA CARTER

40106-KP KIT PARAFUSOS DO CABEÇOTE

40106-KTRT OU 40106 KTRT-F (com ret flange tras.) KIT DE RETENORES DO MOTOR

RET VALVULAS-06X09X10



1219203

RET VIRABREQUIM DIANT

27X37X07



1140049

RET CMD-40X55X07



1145246

FLANGE TRASEIRA



40106 FR

1.4 8V 4C - PALIO / UNO / SIENA / STRADA / PUNTO: 05/ - MTR FIRE (JTA CARTER E ADMISSÃO DIFERENTE)

40103-JGCB	JG JTA MTR S/ CAB	40103-JGRS	JG RETIF MTR S/ CAB
40103-JGSC	JG JTA MTR C/ CAB DE FIBRA	40103-JGRV	JG RETIF MTR C/ CAB DE FIBRA
40103-JGML	JG JTA MTR C/ CAB DE CHAPA	40103-JGRM	JG RETIF MTR C/ CAB DE CHAPA
40103-JRSC	JG JTA MTR C/ CAB DE FIBRA E C/ RET	40103-JRRV	JG RETIF MTR C/ CAB DE FIBRA E RET
40103-JRML	JG JTA MTR C/ CAB DE CHAPA E C/ RET	40103-JRRM	JG RETIF MTR C/ CAB DE CHAPA E RET

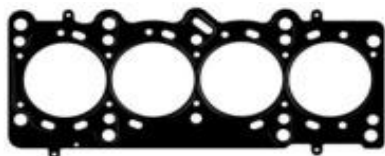

40103 SC - 1,2 MM - 72,5 MM
40103 MLS - 0,5 MM - 72,5 MM
40103 MLS-2M - 1,0 MM - CIL. 72,5 MM
40103 KT - 2,2 MM - CIL. 72,5 MM



40826 BO



40024 PAK / F
JTAS COLETOR ESCAPE



40022 JGBO
JTAS ADMISSÃO



40622 PAK
JTA SAÍDA ESCAPE



40048 NA
JTA TERMOSTATO



40718 BO
SENSOR TEMPERATURA

JG JTA RETIFICAÇÃO



40132 NA
JTA BOMBA DÁGUA

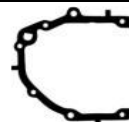

40169 NA
JTA DISTRIBUIÇÃO/ BBA ÓLEO

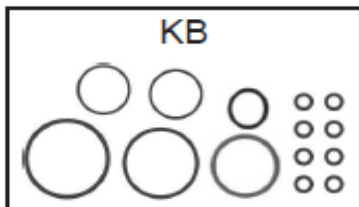

40180 KTBO
KIT VEDADORES MOTOR



40117 BO/CB/CBBO
JTA CARTER

40105-KP
KIT PARAFUSOS DO CABEÇOTE

40103-KTRT 40103 KTRT-F (com ret flange tras.)
KIT DE RETENORES DO MOTOR

RET VALVULAS-05X08X08



1240079

RET CMD-30X42X07



1145093

RET GIRABREQUIM DIANT-
27X37X07



1140049

FLANGE TRASEIRA



1140153

1.4 8V 4C - PALIO / UNO / SIENA / STRADA / PUNTO : 05/ - FIRE FLEX (JTA CARTER E ADMISSÃO DIFERENTE)

40109-JGCB	JG JTA MTR S/ CAB	40109-JGRS	JG RETIF MTR S/ CAB
40109-JGSC	JG JTA MTR C/ CAB DE FIBRA	40109-JGRV	JG RETIF MTR C/ CAB DE FIBRA
40109-JGML	JG JTA MTR C/ CAB DE CHAPA	40109-JGRM	JG RETIF MTR C/ CAB DE CHAPA
40109-JRSC	JG JTA MTR C/ CAB DE FIBRA E C/ RET	40109-JRRV	JG RETIF MTR C/ CAB DE FIBRA E RET
40109-JRML	JG JTA MTR C/ CAB DE CHAPA E C/ RET	40109-JRRM	JG RETIF MTR C/ CAB DE CHAPA E RET



40103 SC - 1,2 MM - 72,5 MM
 40103 MLS - 0,5 MM - 72,5 MM
 40103 MLS-2M - 1,0 MM - CIL. 72,5 MM
 40103 KT - 2,2 MM - CIL. 72,5 MM



40826 BO



40024 PAK / F
 JTAS COLETOR ESCAPE



40019 JGBO
 JTAS ADMISSÃO



40622 PAK
 JTA SAÍDA ESCAPE



40048 NA
 JTA TERMOSTATO



40718 BO
 SENSOR TEMPERATURA

JG JTA RETIFICAÇÃO



40132 NA
 JTA BOMBA D'ÁGUA



40169 NA
 JTA DISTRIBUIÇÃO/ BBA ÓLEO

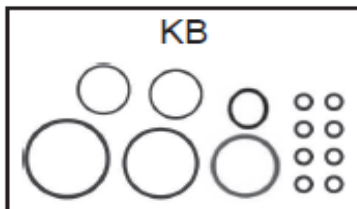

40180 KTBO
 KIT VEDADORES MOTOR



40117 PAK/CB/PV
 JTA CARTER

40105-KP
KIT PARAFUSOS DO CABEÇOTE

40103-KTRT **40103 KTRT-F (com ret flange tras.)**
KIT DE RETENORES DO MOTOR

RET VALVULAS-05X08X08



1240079

RET CMD-30X42X07



1145093

RET GIRABREQUIM DIANT-
 27X37X07



1140049

FLANGE TRASEIRA



1140153

1.4 16V 4C - PUNTO / IDEA / BRAVO / LINEA : 07/ - MTR T-JET MOTOR 192B2000 - GAS

40111-JGCB	JG JTA MTR S/ CAB	40111-JGRS	JG RETIF MTR S/ CAB
40111-JGSC	JG JTA MTR C/ CAB DE FIBRA	40111-JGRV	JG RETIF MTR C/ CAB DE FIBRA
40111-JGML	JG JTA MTR C/ CAB DE CHAPA	40111-JGRM	JG RETIF MTR C/ CAB DE CHAPA
40111-JRSC	JG JTA MTR C/ CAB DE FIBRA E C/ RET	40111-JRRV	JG RETIF MTR C/ CAB DE FIBRA E RET
40111-JRML	JG JTA MTR C/ CAB DE CHAPA E C/ RET	40111-JRRM	JG RETIF MTR C/ CAB DE CHAPA E RET



40104 MLS - 0,5 MM - CIL. 72,5 MM
40104 SC - 1,2 MM - CIL. 72,5 MM
JTA CABEÇOTE 72.5 MM

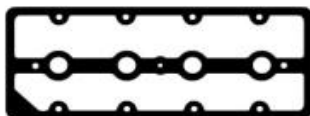

40126 MLS/NA
JTA TAMPA DE VÁLVULAS



40124 PAK



40023 JGBO



40167 NA
JTA



40048 NA
JTA TERMOSTATO



40168 PAK
JTA SAÍDA ESCAPE

JG JTA RETIFICAÇÃO



40132 NA
JTA BOMBA D'ÁGUA



40169 NA
JTA DISTRIBUIÇÃO /
BBA ÓLEO



40181 KTBO
KIT VEDADORES MOTOR

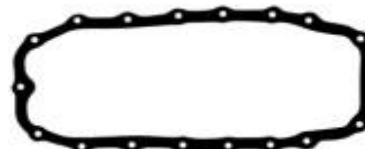

40120 PAK/CB/PV
JTA CARTER

40106-KP
KIT PARAFUSOS DO CABEÇOTE

40111-KTRT 40111 KTRT-F (com ret flange tras.)
KIT DE RETENORES DO MOTOR

RET VALVULAS-05X08X08

RET CMD-40X55X07



1240079



1145246

RET VIRABREQUIM DIANT

FLANGE TRASEIRA

27X37X07



1140049



1140153

1.5 8V 4C - UNO / PRÊMIO / ELBA: 85/89 - SEVEL (ARGENTINO)

40506-JGCB	JG JTA MTR S/ CAB	40506-JGRS	JG RETIF MTR S/ CAB
40506-JGSC	JG JTA MTR C/ CAB DE FIBRA	40506-JGRV	JG RETIF MTR C/ CAB DE FIBRA
40506-JRSC	JG JTA MTR C/ CAB DE FIBRA E C/ RET	40506-JRRV	JG RETIF MTR C/ CAB DE FIBRA E RET

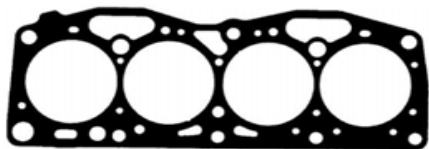

40501 SC - 1,9 MM - CIL. 87 MM
40501 KT - 2,9 MM - CIL. 87 MM
40501 TB - 2,4 MM - CIL. 87MM



40526 CB
JTA TAMPAS DE VÁLVULAS



40525 PV (0,4 MM)
40525 PV (0,8 MM)
40525 GV (0,4 MM)
JTA SUPERIOR DE VÁLVULAS



40546 NA
JTA DA BOMBA AO

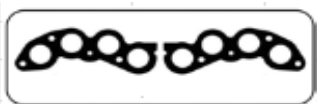

40521 PAK
JTA ADMISSÃO



40522 PAK
40522 F
JTA SAÍDA ESCAPE



40341 NA
FLANGE ENTRADA



40547 NA
JTA BOCAL DA SAÍDA



40527 NA
JTA TAMPAS ÓLEO

JG JTA RETIFICAÇÃO



40535 GV
JTA TAMPAS DO ÓLEO



40345 NA
JTA BASE DO DISTRIBUIDOR



40538 NA
JTA TUBO DA BOMBA DE ÓLEO



40541 NA
JTA CORPO DA BOMBA D'AGUA



40537 NA
JTA RESPIRO DO MOTOR



40534 NA
FLANGE ENTRADA BOMBA D'AGUA



40531 NA
JTA TAMPAS DIANTEIRA BLOCO MOTOR



40543 NA
JTA BOMBA



40544 NA
JTA BOMBA COMBUSTÍVEL



40545 NA
JTA BOMBA



40530 NA
JTA BOMBA COMBUSTÍVEL



40528 GV
40528 NA
JTA TPA DIANTEIRA



40529 GV
40529 NA
JTA TPA TRASEIRA DISTRIBUIÇÃO



40536 PP
JTA BOMBA



40238 PP
JTA BOMBA DE ÓLEO

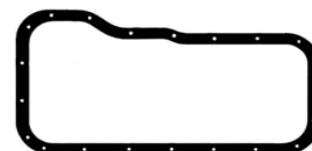

40516 CB
40516 NA

40506-KP

KIT PARAFUSOS DO CABEÇOTE

40506-KTRT

KIT DE RETENORES DO MOTOR

RET VALVULAS-08X11X10



1212544

RET VIRABREQUIM DIANT

40X56X07



1142005

RET COMANDO-30X52X07



1142006

RET VIRABREQUIM TRAS











64X80X08

















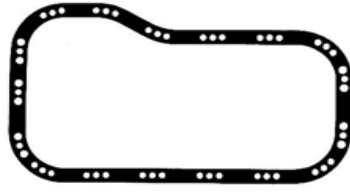

1142004

1.5 8V 4C - MOTOR FIAT 1500 - FIASA

40408-JGCB	JG JTA MTR S/ CAB	40408-JGRS	JG RETIF MTR S/ CAB
40408-JGSC	JG JTA MTR C/ CAB DE FIBRA	40408-JGRV	JG RETIF MTR C/ CAB DE FIBRA
40408-JGML	JG JTA MTR C/ CAB DE CHAPA	40408-JGRM	JG RETIF MTR C/ CAB DE CHAPA
40408-JRSC	JG JTA MTR C/ CAB DE FIBRA E C/ RET	40408-JRRV	JG RETIF MTR C/ CAB DE FIBRA E RET
40408-JRML	JG JTA MTR C/ CAB DE CHAPA E C/ RET	40408-JRRM	JG RETIF MTR C/ CAB DE CHAPA E RET

		
40302 SC - 1,9 MM - CIL. 77 MM 40302 KT - 2,9 MM - CIL. 77 MM 40302 TB - 2,4 MM - CIL. 77 MM	40326 CB JTA TAMPA DE VÁLVULAS	40420 PAK JTA ADM ESC
		
40322 PAK 40322 F JTA ESCAPE	40339 NA JTA TUBULAÇÃO D'AGUA	40337 NA JTA CORPO BOMBA D'AGUA AO BLOCO
		
40341 NA TA CANO D'AGUA	40336 NA JTA DO COMANDO	40342 GV JTA DO TERMOSTATO
		
40330 NA JTA BOMBA	40335 NA JTA BASE CARBURADOR	
JG JTA RETIFICAÇÃO		

						
40331 GV JTA CORPO BOMBA	40338 NA JTA TAMPA DIANTEIRA	40340 NA JTA TPA TRASEIRA	40343 NA JTA BOMBA	40344 NA JTA BOMBA	40348 NA JTA DO	40345 NA JTA BASE DO
						
40333 NA JTA TAMPA DIANTEIRA	40334 NA JTA TAMPA TRASEIRA BLOCO	40347 NA JTA TAMPA GIRABREQUIM	40349 NA JTA TAMPA DIANTEIRA	40317 CB JTA CARTER		
						
40329 GV JTA CARÇAÇA DISTRIBUIÇÃO	40328 GV JTA TPA DISTRIBUIÇÃO	40332 PP JTA CORPO BOMBA	40536 PP JUNTA	40538 PP JTA BOMBA		

40409-KP
KIT PARAFUSOS DO CABEÇOTE

40307-KTRT
KIT DE RETENORES DO MOTOR

RET VALVULAS-08X11X10	RET COMANDO-30X52X07
	
1212544	1142006
RET VIRABREQUIM DIANT	RET VIRABREQUIM TRAS
40X56X07	70X85X08
	
1142005	1142269

1.6 8V 4C - UNO / PRÊMIO / ELBA: 89/ SEVEL (ARGENTINO)

40606-JGCB	JG JTA MTR S/ CAB	40606-JGRS	JG RETIF MTR S/ CAB
40606-JGSC	JG JTA MTR C/ CAB DE FIBRA	40606-JGRV	JG RETIF MTR C/ CAB DE FIBRA
40606-JRSC	JG JTA MTR C/ CAB DE FIBRA E C/ RET	40606-JRRV	JG RETIF MTR C/ CAB DE FIBRA E RET

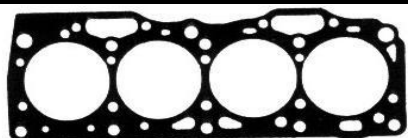

40601 SC - 1,9 MM - CIL. 87 MM
 40601 KT - 2,9 MM - CIL. 87 MM
 40601 TB - 2,4 MM - CIL. 87 MM
 JTA CABEÇOTE



40626 CB
 JTA TAMPAS DE VÁLVULAS



40525 PV (0,4 MM)
 40525 PV (0,8 MM)
 40525 GV (0,4 MM)
 JTA SUPERIOR DE VÁLVULAS

40546 NA
 JTA DA BOMBA



40621 PAK
 JTA ADMISSÃO E ESCAPE



40522 PAK
 40522 F



40547 NA
 JTA BOCAL DA
 SAÍDA DE AGUA



40341 NA
 FLANGE ENTRADA
 BOMBA D'AGUA



40527 NA
 JTA TAMPAS ÓLEO



40633 NA
 JTA VÁLVULA

JG JTA RETIFICAÇÃO



40535 GV
 JTA TAMPAS DO
 ÓLEO



40637 NA
 JTA TAMPAS POSTERIOR



40538 NA
 JTA TUBO DA
 BOMBA DE ÓLEO



40537 NA
 JTA RESPIRO DO
 MOTOR



40537 NA
 JTA RESPIRO
 DO MOTOR



40541 NA
 JTA CORPO DA



40534 NA
 FLANGE ENTRADA



40531 NA
 JTA TAMPAS DIANTEIRA
 BLOCO MOTOR



40543 NA
 JTA BOMBA



40544 NA
 JTA BOMBA
 COMBUSTÍVEL



40545 NA
 JTA BOMBA



40330 NA
 JTA BOMBA
 COMBUSTÍVEL



40345 NA
 JTA BASE DO
 DISTRIBUIDOR



40528 GV
 40528 NA
 JTA TPA DIANTEIRA
 DISTRIBUIÇÃO



40529 GV
 40529 NA
 JTA TPA TRASEIRA
 DISTRIBUIÇÃO



40536 PP
 JTA BOMBA
 ÓLEO



40238 PP
 JTA BOMBA DE



40516 CB
 40516 NA

40606-KP

KIT PARAFUSOS DO CABEÇOTE

40506-KTRT

KIT DE RETENORES DO MOTOR

RET VALVULAS-08X11X10



1212544

RET VIRABREQUIM DIANT

40X56X07



1142005

RET COMANDO-30X52X07



1142006

RET VIRABREQUIM TRAS

64X80X08



1142004

1.6 8V 4C - TIPO / PALIO: 93/95 SEVEL (ARGENTINO)

40210-JGCB	JG JTA MTR S/ CAB	40210-JGRS	JG RETIF MTR S/ CAB
40210-JGSC	JG JTA MTR C/ CAB DE FIBRA	40210-JGRV	JG RETIF MTR C/ CAB DE FIBRA
40210-JRSC	JG JTA MTR C/ CAB DE FIBRA E C/ RET	40210-JRRV	JG RETIF MTR C/ CAB DE FIBRA E RET

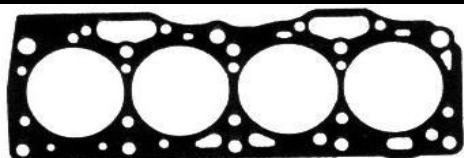

40601 SC - 1,9 MM - CIL. 87 MM
40601 KT - 2,9 MM - CIL. 87 MM
40601 TB - 2,4 MM - CIL. 87 MM
JTA CABEÇOTE



40227 CB
JTA TAMPA DE VÁLVULAS



40827 NA



40546 NA
JTA DA BOMBA
AO BLOCO



40821 PAK
JTA COL ADM/ESCAPE



40522 PAK
40522 F
JTA SAÍDA ESCAPE



40527 NA
JTA TAMPA ÓLEO
COMANDO



40637 NA
JTA TAMPA
POSTERIOR
COMANDO



40341 NA
FLANGE
ENTRADA



40645 NA
JTA VÁLVULA

JG JTA RETIFICAÇÃO



40535 GV
JTA TAMPA



40541 NA
JTA CORPO DA
BOMBA D'AGUA



40534 NA
FLANGE ENTRADA
BOMBA D'AGUA



40537 NA
JTA RESPIRO DO
MOTOR



40528 GV
40528 NA
JTA TPA DIANTEIRA
DISTRIBUIÇÃO



40529 GV
40529 NA
JTA TPA TRASEIRA
DISTRIBUIÇÃO



40536 PP
JTA BOMBA ÓLEO

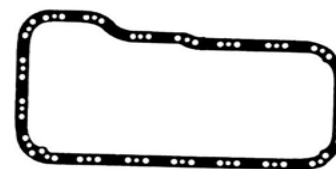

40616 CB
40616 GV
40616 NA
JTA CARTER

40606-KP

KIT PARAFUSOS DO CABEÇOTE

40506-KTRT

KIT DE RETENORES DO MOTOR

RET VALVULAS-08X11X10



1212544

RET VIRABREQUIM DIANT

40X56X07



1142005

RET COMANDO-30X52X07



1142006

RET VIRABREQUIM TRAS

64X80X08



1142004

1.6 16V 4C - PÁLIO / SIENA / STRADA / BRAVO / STYLO / MAREA / TIPO: 96/02 - PISTÃO 86,4MM - MTR 178B3 / 182A4

40805-JGCB	JG JTA MTR S/ CAB	40805-JGRS	JG RETIF MTR S/ CAB
40805-JGSC	JG JTA MTR C/ CAB DE FIBRA	40805-JGRV	JG RETIF MTR C/ CAB DE FIBRA
40805-JRSC	JG JTA MTR C/ CAB DE FIBRA E C/ RET	40805-JRRV	JG RETIF MTR C/ CAB DE FIBRA E RET



40403 SC - 1,9 MM - CIL. 87 MM
40403 KT - 2,9 MM - CIL. 87 MM
40403 TB - 2,4 MM - CIL. 87 MM

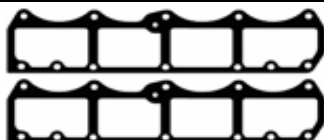

40157 PAK
40147 CV
40157 NA
40157 GV 0,8
40157 KTNA (PAR)
JTA SUPERIOR DO CABEÇOTE



40533 NA
JTA BOMBA



40021 PAK - JUNTA DA ADMISSÃO



40031 PAK-JTA COLETOR DE ESCAPE



40041 JG BO
JTA ADMISSÃO PALIO



40112 NA
JTA INJEÇÃO
ELETRÔNICA



40168 PAK
JTA ESCAPE

JG JTA RETIFICAÇÃO



40535 GV
JTA TAMPA
DO ÓLEO



40536 PP
JTA BOMBA



40636 NA
JTA BOMBA DE ÓLEO



40528 GV
JTA TPA
DIANTEIRA



40529 GV
JTA TPA
TRASEIRA

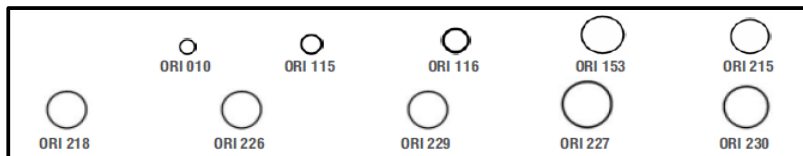

40805 - KTBO
JOGO DE BORRACHAS DO MOTOR



40537 NA
JTA RESPIRO DO MOTOR



40516 PAK CB
JTA CARTER

40805-KP KIT PARAFUSOS DO CABEÇOTE

40805-KTRT OU 40805 KTRT-F (com ret flange tras.) KIT DE RETENTORES DO MOTOR

RET VALVULAS-07X10X10



1213044

RET CMD-30X52X07/30X47X07



1142006 - 1145202

RET GIRABREQUIM DIANT-
40X56X07



1142005

FLANGE TRASEIRA



40805 FR

1.6 16V 4C - PÁLIO / SIENA / DOBLO / STYLO / MAREA 01 / BRAVA /00 - FLEX - PISTÃO 80MM - MTR 182B6 / 178E7

40806JGCB	JG JTA MTR S/ CAB	40806-JGRS	JG RETIF MTR S/ CAB
40806-JGSC	JG JTA MTR C/ CAB DE FIBRA	40806-JGRV	JG RETIF MTR C/ CAB DE FIBRA
40806-JGML	JG JTA MTR C/ CAB DE CHAPA	40806-JGRM	JG RETIF MTR C/ CAB DE CHAPA
40806-JRSC	JG JTA MTR C/ CAB DE FIBRA E C/ RET	40806-JRRV	JG RETIF MTR C/ CAB DE FIBRA E RET
40806-JRML	JG JTA MTR C/ CAB DE CHAPA E C/ RET	40806-JRRM	JG RETIF MTR C/ CAB DE CHAPA E RET



40404 SC - 1,5 MM - CIL. 82 MM
 40404 MLS - 1,2 MM - CIL. 82 MM
 40404 MLS -2M - 2,2 MM - CIL. 82 MM
 40404 KT - 2,5 MM - CIL. 82 MM



40021 PAK - JTA DA ADMISSÃO

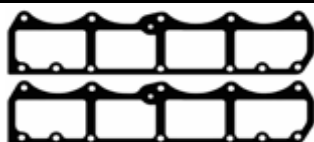

40157 PAK
 40147 CV
 40157 NA
 40157 GV 0,8
 40157 KTNA (PAR)
 JTA SUPERIOR DO CABEÇOTE



40042 JGBO
 JTA ADMISSÃO



40031 PAK-JTA COLETOR DE ESCAPE



40112 NA
 JTA INJEÇÃO
 ELETRÔNICA



40533 NA
 JTA BOMBA



40168 PAK
 JTA ESCAPE

JG JTA RETIFICAÇÃO



40535 GV
 JTA TAMPA
 DO ÓLEO



40536 PP
 JTA BOMBA



40636 NA
 JTA BOMBA DE ÓLEO



40528 GV
 JTA TPA
 DIANTEIRA



40529 GV
 JTA TPA
 TRASEIRA

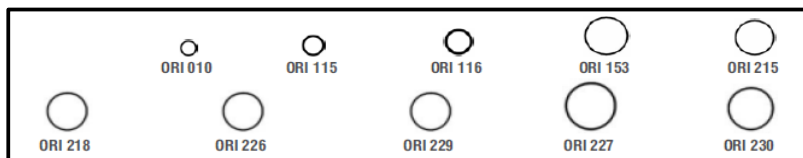

40805 - KTBO
 JOGO DE BORRACHAS DO MOTOR



40537 NA
 JTA RESPIRO DO MOTOR



40616 CB / NA
 JTA CARTER



262027
 ANEL BUJÃO CARTER

40805-KP KIT PARAFUSOS DO CABEÇOTE

40806-KTRT

40806 KTRT-F (com ret flange tras.)

KIT DE RETENTORES DO MOTOR

RET VALVULAS-07X10X10



1213044

RET CMD-30X52X07/30X42X07



1142006 - 1145202

RET GIRABREQUIM DIANT- 40X56X07



1142005

FLANGE TRASEIRA



40805 FR

1.6 16V 4C - FIAT - PALIO / GRAND SIENA / PUNTO / IDEA / STRADA / DOBLO : /13 - ETORQ FLEX

1.6 16V 4C - MINI - COOPER S / ONE CABRIO : /13- ETORQ FLEX

41106-JGCB	JG JTA MTR S/ CAB	41106-JGRS	JG RETIF MTR S/ CAB
41106-JGSC	JG JTA MTR C/ CAB DE FIBRA	41106-JGRV	JG RETIF MTR C/ CAB DE FIBRA
41106-JGML	JG JTA MTR C/ CAB DE CHAPA	41106-JGRM	JG RETIF MTR C/ CAB DE CHAPA
41106-JRSC	JG JTA MTR C/ CAB DE FIBRA E C/ RET	41106-JRRV	JG RETIF MTR C/ CAB DE FIBRA E RET
41106-JRML	JG JTA MTR C/ CAB DE CHAPA E C/ RET	41106-JRRM	JG RETIF MTR C/ CAB DE CHAPA E RET

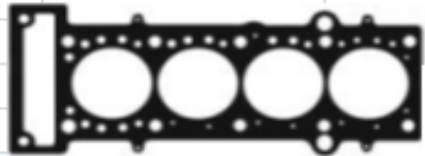

41103 SC - 1,2 MM - CIL. 78 MM
 41103 MLS - 0,7 MM - CIL. 78 MM
 41103 MLS-1M - 1,0 MM - CIL. 78 MM
 JTA CABEÇOTE



41120-JGBO

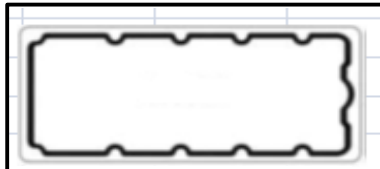

41126 BO JTA TAMPA VÁLVULAS



41126 JGBO-PA VED PARAFUSO TV



41145 JGBO JG VEDADOR VELAS TV

41126 KTBO KIT JTA TAMPA DE VÁLVULAS



41121 F
 JUNTA COLETOR
 ESCAPE



10720 PAK
 10720 FA
 JUNTA DO ESCAPE



41135 BO
 JTA SENSOR
 TEMPERATURA

JG JTA RETIFICAÇÃO

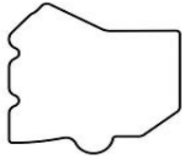

41144 BO
 JTA DISTRIBUIDOR

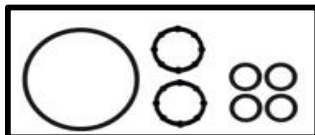

41106 KTBO
 KIT VEDADORES MOTOR



41136-BO
 JTA BBA ÓLEO



41116 PAK
 JTA CARTER

41106-KP
 KIT PARAFUSOS DO CABEÇOTE

41105-KTRT
 KIT DE RETENORES DO MOTOR
 RET VÁLVULAS-06X10,5X18



RET VIRABREQUIM DIANT

32X45X06



1140087

RET VIRABREQUIM TRAS

91X111X10



1140187

1.6 16V 4C - DOBLO / PALIO / GRAND SIENA / PUNTO / IDEA / STRADA : 13/ MTR ETORQ EVO FLEX

41108-JGCB	JG JTA MTR S/ CAB	41108-JGRS	JG RETIF MTR S/ CAB
41108-JGSC	JG JTA MTR C/ CAB DE FIBRA	41108-JGRV	JG RETIF MTR C/ CAB DE FIBRA
41108-JGML	JG JTA MTR C/ CAB DE CHAPA	41108-JGRM	JG RETIF MTR C/ CAB DE CHAPA
41108-JRSC	JG JTA MTR C/ CAB DE FIBRA E C/ RET	41108-JRRV	JG RETIF MTR C/ CAB DE FIBRA E RET
41108-JRML	JG JTA MTR C/ CAB DE CHAPA E C/ RET	41108-JRRM	JG RETIF MTR C/ CAB DE CHAPA E RET

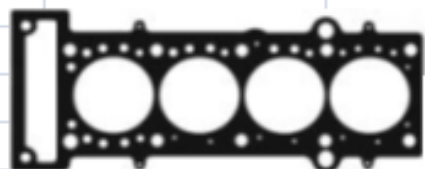

41401SC - 1,2 MM - CIL. 78 MM
41401MLS - 0,7 MM - CIL. 78 MM
JTA CABEÇOTE



41120-JGBO

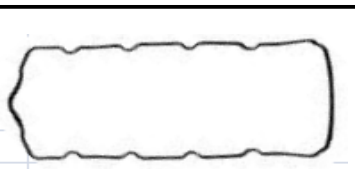

41127 BO JTA TAMPA VÁLVULAS



41126 JGBO-PA VED PARAFUSO TV



41145 JGBO JG VEDADOR VELAS TV

41127 KTBO KIT JTA TAMPA DE VÁLVULAS



41121 F
JUNTA COLETOR
ESCAPE



10720 PAK
10720 FA
JUNTA DO ESCAPE



41135 BO
JTA SENSOR
TEMPERATURA

JG JTA RETIFICAÇÃO

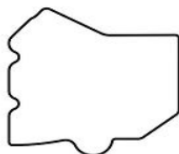

41144 BO
JTA DISTRIBUIDOR



41136-BO
JTA BBA ÓLEO

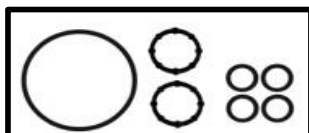

41106 KTBO
KIT VEDADORES MOTOR



41116 PAK
JTA CARTER

41106-KP
KIT PARAFUSOS DO CABEÇOTE

41105-KTRT
KIT DE RETENTORES DO MOTOR
RET VÁLVULAS-06X10,5X18



RET VIRABREQUIM DIANT

32X45X06



1140087

RET VIRABREQUIM TRAS

91X111X10



1140187

1.9 16V 4C - LINEA 07/ - FLEX

40807JGCB	JG JTA MTR S/ CAB	40807-JGRS	JG RETIF MTR S/ CAB
40807-JGSC	JG JTA MTR C/ CAB DE FIBRA	40807-JGRV	JG RETIF MTR C/ CAB DE FIBRA
40807-JRSC	JG JTA MTR C/ CAB DE FIBRA E C/ RET	40807-JRRV	JG RETIF MTR C/ CAB DE FIBRA E RET



40403 SC - 1,9 MM - CIL. 87 MM
40403 KT - 2,9 MM - CIL. 87 MM
40403 TB - 2,4 MM - CIL. 87 MM

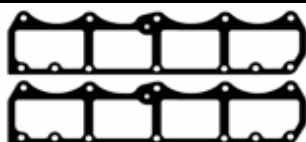

40157-PAK/CV/NA



40031 PAK
JTA COLETOR DE ESCAPE



40021 PAK
JTA ADMISSÃO



40042 JGBO
JTA ADMISSÃO



40112 NA
JTA INJEÇÃO



40533 NA
JTA BOMBA



40168 PAK
JTA ESCAPE

JG JTA RETIFICAÇÃO



40535 GV
JTA TAMPA DO ÓLEO



40536 PP
JTA BOMBA



40636 NA
JTA BOMBA DE ÓLEO



40528 GV
JTA TPA DIANTEIRA DISTRIBUIÇÃO



40529 GV
JTA TPA TRASEIRA DISTRIBUIÇÃO

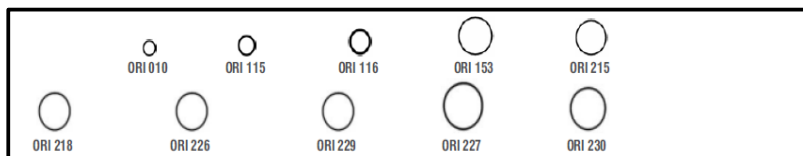

40805 - KTBO
JOGO DE BORRACHAS DO MOTOR



40537 NA
JTA RESPIRO DO MOTOR



40616 CB / NA
JTA CARTER



262027
ANEL BUJÃO CARTER

40805-KP KIT PARAFUSOS DO CABEÇOTE

40806-KTRT 40806 KTRT-F (com ret flange tras.) KIT DE RETENTORES DO MOTOR

RET VALVULAS-07X10X10



1213044

RET CMD-30X52X07/30X42X07



1142006 - 1145202

RET GIRABREQUIM DIANT-40X56X07



1142005

FLANGE TRASEIRA



40805 FR

1.8 8V 4C - FIAT - PALIO R / STRADA / STILO / DOBLO : 03/ - MTR POWER FLEX

1.8 8V 4C - GM - CORSA / MERIVA / MONTANA / SPIN : 03/ - MTR POWER FLEX

10007-JGCB	JG JTA MTR S/ CAB	10007-JGRS	JG RETIF MTR S/ CAB
10007-JGSC	JG JTA MTR C/ CAB DE FIBRA	10007-JGRV	JG RETIF MTR C/ CAB DE FIBRA
10007-JGML	JG JTA MTR C/ CAB DE CHAPA	10007-JGRM	JG RETIF MTR C/ CAB DE CHAPA
10007-JRSC	JG JTA MTR C/ CAB DE FIBRA E C/ RET	10007-JRRV	JG RETIF MTR C/ CAB DE FIBRA E RET
10007-JRML	JG JTA MTR C/ CAB DE CHAPA E C/ RET	10007-JRRM	JG RETIF MTR C/ CAB DE CHAPA E RET

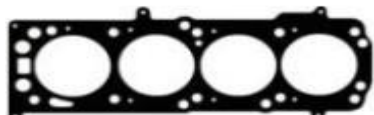

10302 SC / MLS
JTA CABEÇOTE

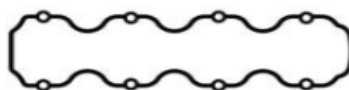

10326 BO
JTA TAMPA VALV
Nº ORIG: 90354545



10222 PAK
JTA TUBAGEM
NºORIG: 93227660

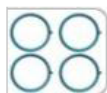

09420-BO
JG JTA ADMISSÃO



10223 NA
JTA ADMISSÃO
Nº ORIG: 90409709



10822 PAK
JTA SAÍDA ESC.
Nº ORIG: 90128293



10433 NA
JTA INJ. ELETRÔNICA
Nº ORIG: 90411524



10422 PAK
JTA SAÍDA ESC.

JG JTA RETIFICAÇÃO



09418 BO
JTA SENSOR
TEMPERATURA



10856 BO
ANEL BORR.
Nº ORIG: 11069011



40719 BO
JTA SENSOR



10036 BO
KIT BORRACHAS MOTOR



10884 NA
JTA DISTRIBUIÇÃO
Nº ORIG: 90353564



10059 NA
JTA BBA ÓLEO
Nº ORIG: 90076127



10888 NA
JTA VENTILAÇÃO DO
CARTER



261420
ANEL BUJÃO CARTER
Nº ORIG: 11023582



10217 CB
JTA CARTER
Nº ORIG: 90409693

10912-KP

KIT PARAFUSOS DO CABEÇOTE

10209-KTRT

KIT DE RETENORES DO MOTOR

RET VALVULAS-06X09X10



1222509

RET GIRABREQUIM TRASEIRO-
80X98X10



1122524

RET COMANDO-35X48X07



1122178

RET GIRABREQUIM
DIANTEIRO- 26X42X08



1122525

1.8 16V 4C - FIAT - STILO 03/ DOHC

1.8 16V 4C - GM - MERIVA 03/ DOHC

41006-JGCB	JG JTA MTR S/ CAB	41006-JGRS	JG RETIF MTR S/ CAB
41006-JGSC	JG JTA MTR C/ CAB DE FIBRA	41006-JGRV	JG RETIF MTR C/ CAB DE FIBRA
41006-JGML	JG JTA MTR C/ CAB DE CHAPA	41006-JGRM	JG RETIF MTR C/ CAB DE CHAPA
41006-JRSC	JG JTA MTR C/ CAB DE FIBRA E C/ RET	41006-JRRV	JG RETIF MTR C/ CAB DE FIBRA E RET
41006-JRML	JG JTA MTR C/ CAB DE CHAPA E C/ RET	41006-JRRM	JG RETIF MTR C/ CAB DE CHAPA E RET



10301 SC/MLS
JTA CABEÇOTE

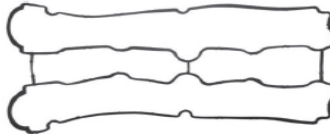

41026-BO



10224 PAK
JTA ADMISSÃO



10221 PAK
JTA INFERIOR COL.
Nº ORIG: 90470032



10822 PAK
JTA SAÍDA ESC.
Nº ORIG: 90128293



10491 NA
JTA INJ. ELETRÔNICA
Nº ORIG: 90470736



10004 BO
ANEL TERMOSTATO
Nº ORIG: 90096383

JG JTA RETIFICAÇÃO



10888 NA
JTA TUBAGEM
Nº ORIG: 90500068



10884 NA
JTA DISTRIBUIÇÃO
Nº ORIG: 90353564



261420
ANEL BUJÃO CARTER



262024
ARR. DE COBRE
20X24X1.5



ORI - 114
ANEL DE BORR. 15,3X2,4

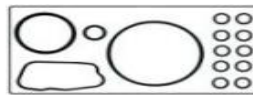

10033 BO
KIT DE BORRACHAS.

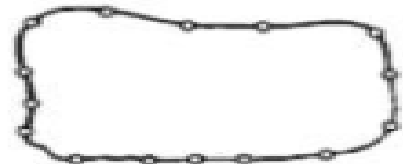

10316 BO
JTA CARTER
Nº ORIG: 9041896

10917-KP
KIT PARAFUSOS DO CABEÇOTE

41006-KTRT
KIT DE RETENORES DO MOTOR

RET VALVULAS-06X09X10



1219203

RET COMANDO-35X48X07



1122178

RET GIRABREQUIM TRASEIRO-
80X98X10



1122524

RET GIRABREQUIM
DIANTEIRO- 30X42X07



1122525

1.8 16V 4C - MAREA / BRAVA : 95/ - MTR 182A2

40901-JGCB	JG JTA MTR S/ CAB	40901-JGRS	JG RETIF MTR S/ CAB
40901-JGSC	JG JTA MTR C/ CAB DE FIBRA	40901-JGRV	JG RETIF MTR C/ CAB DE FIBRA
40901-JRSC	JG JTA MTR C/ CAB DE FIBRA E C/ RET	40901-JRRV	JG RETIF MTR C/ CAB DE FIBRA E RET



52002 SC - 2,0 MM - CIL. 83 MM
 52002 KT - 3,0 MM - CIL. 83 MM
 52002 TB - 2,5 MM - CIL. 83 MM
 JTA CABEÇOTE



40923 F
 JTA COLETOR ESCAPE

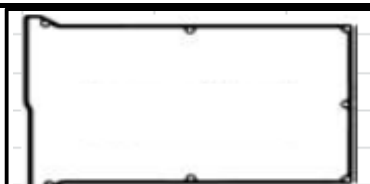

40936 KTBO - JTA TAMPA VÁLVULAS



40941 JGBO - JOGO VEDADORES DA TV

40936 KTBO - KIT DE JUNTAS DA TV



40920 PAK
 JTA DO ESCAPE



40922 PAK
 JTA ADMISSÃO



40872 NA
 JTA INJEÇÃO
 ELETRÔNICA

JG JTA RETIFICAÇÃO



161822
 ANEL BUJÃO CARTER



40935 NA
 JTA CANO D'ÁGUA



40841 NA
 JTA CANO DE ÓLEO



40930 NA
 JTA BOMBA DE ÓLEO



40901-KTBO
 KIT DE BORRACHAS



40815 NA
 JTA INFERIOR DO
 CARTER



40917 CB
 JTA CARTER

40402-KP
 KIT PARAFUSOS DO CABEÇOTE

40901-KTRT 40901 KTRT-F (com ret flange tras.)
 KIT DE RETENORES DO MOTOR

RET VALVULAS-07X10X10

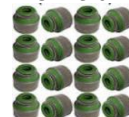

1213044

RET VIRABREQUIM DIANT

31X47X07



1140057

RET CMD-55X68X08/30X42X07



1140157 - 1145093

FLANGE TRASEIRA



40402 FR

1.8 16V 4C - FIAT - G SIENA / PUNTO / BRAVO / LINEA / STRADA / DOBLO / IDEA : /13 - ETORQ FLEX

1.8 16V 4C - CHRYSLER - PT CRUISER /13 - ETORQ FLEX

41105-JGCB	JG JTA MTR S/ CAB	41105-JGRS	JG RETIF MTR S/ CAB
41105-JGSC	JG JTA MTR C/ CAB DE FIBRA	41105-JGRV	JG RETIF MTR C/ CAB DE FIBRA
41105-JGML	JG JTA MTR C/ CAB DE CHAPA	41105-JGRM	JG RETIF MTR C/ CAB DE CHAPA
41105-JRSC	JG JTA MTR C/ CAB DE FIBRA E C/ RET	41105-JRRV	JG RETIF MTR C/ CAB DE FIBRA E RET
41105-JRML	JG JTA MTR C/ CAB DE CHAPA E C/ RET	41105-JRRM	JG RETIF MTR C/ CAB DE CHAPA E RET

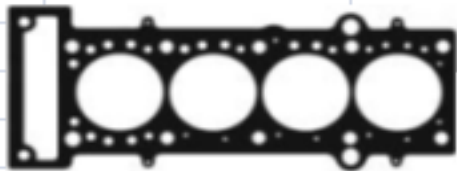

41102 SC - 1,2 MM - CIL. 82,2 MM
 41102 MLS - 0,7 MM - CIL. 82,2 MM
 41102-MLS-1M - 1,0 MM - CIL. 82,2 MM
 JTA CABEÇOTE



41120-JGBO

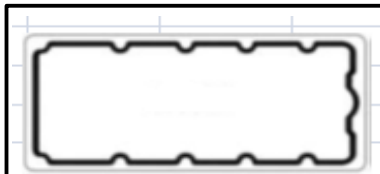

41126 BO JTA TAMPA VÁLVULAS



41126 JGBO-PA VED PARAFUSO TV



41145 JGBO JG VEDADOR VELAS TV

41126 KTBO KIT JTA TAMPA DE VÁLVULAS



41121 F
 JUNTA COLETOR
 ESCAPE



10720 PAK
 10720 FA
 JUNTA DO ESCAPE



41135 BO
 JTA SENSOR
 TEMPERATURA

JG JTA RETIFICAÇÃO

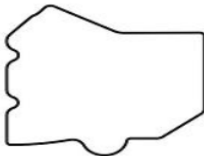

41144 BO
 JTA DISTRIBUIDOR



41136-BO
 JTA BBA ÓLEO

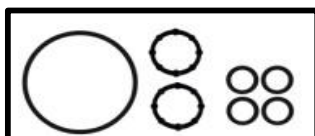

41106 KTBO
 KIT VEDADORES MOTOR



41116 PAK
 JTA CARTER

41106-KP
 KIT PARAFUSOS DO CABEÇOTE

41105-KTRT
 KIT DE RETENORES DO MOTOR
 RET VÁLVULAS-06X10,5X18



RET VIRABREQUIM DIANT

RET VIRABREQUIM TRAS

32X45X06

91X111X10



1140087

1140187

1.8 16V 4C - FIAT - ARGO / CRONOS / TORO / DOBLO / GRAN SIENA / PALIO 13/ - MTR ETORQ EVO FLEX
1.8 16V 4C - JEEP - JEEP RENEGADE 13/ - MTR ETORQ EVO FLEX

41107-JGCB	JG JTA MTR S/ CAB	41107-JGRS	JG RETIF MTR S/ CAB
41107-JGSC	JG JTA MTR C/ CAB DE FIBRA	41107-JGRV	JG RETIF MTR C/ CAB DE FIBRA
41107-JGML	JG JTA MTR C/ CAB DE CHAPA	41107-JGRM	JG RETIF MTR C/ CAB DE CHAPA
41107-JRSC	JG JTA MTR C/ CAB DE FIBRA E C/ RET	41107-JRRV	JG RETIF MTR C/ CAB DE FIBRA E RET
41107-JRML	JG JTA MTR C/ CAB DE CHAPA E C/ RET	41107-JRRM	JG RETIF MTR C/ CAB DE CHAPA E RET

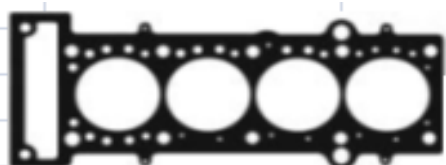

41402 SC - 1,2 MM - CIL. 82,2 MM
 41402 MLS - 0,7 MM - CIL. 82,2 MM
 JTA CABEÇOTE



41120-JGBO

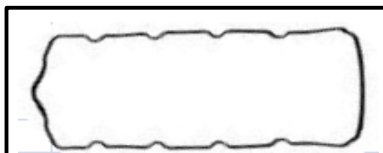

41127BO JTA TAMPA VÁLVULAS



41126 JGBO-PA VED PARAFUSO TV



41145 JGBO JG VEDADOR VELAS TV

41127 KTBO KIT JTA TAMPA DE VÁLVULAS



41121 F
 JUNTA COLETOR
 ESCAPE



10720 PAK
 10720 FA
 JUNTA DO ESCAPE



41135 BO
 JTA SENSOR
 TEMPERATURA

JG JTA RETIFICAÇÃO

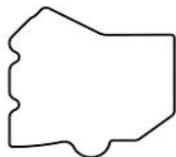

41144 BO
 JTA DISTRIBUIDOR



41136-BO
 JTA BBA ÓLEO

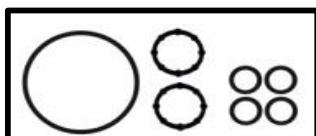

41106 KTBO
 KIT VEDADORES MOTOR



41116 PAK
 JTA CARTER

41106-KP
 KIT PARAFUSOS DO CABEÇOTE

41105-KTRT
 KIT DE RETENORES DO MOTOR
 RET VÁLVULAS-06X10,5X18



RET VIRABREQUIM DIANT

RET VIRABREQUIM TRAS

32X45X06

91X111X10



1140087



1140187

2.0 8V 4C - TIPO / TEMPRA 90/99

40206-JGCB JG JTA MTR S/ CAB

40206-JGSC JG JTA MTR C/ CAB DE FIBRA

40206-JRSC JG JTA MTR C/ CAB DE FIBRA E C/ RET

40206-JGRS JG RETIF MTR S/ CAB

40206-JGRV JG RETIF MTR C/ CAB DE FIBRA

40206-JRRV JG RETIF MTR C/ CAB DE FIBRA E RET



40201 SC - 1,9 MM - CIL. 85 MM
40201 KT - 2,9 MM - CIL. 85 MM
40201 TB - 2,4 MM - CIL. 85 MM



40137 NA
40137 GV 0,4
40137 GV 0,8
40137 SC
JTA LATERAL TAMPA VÁLVULAS



40131 PAK
40131 CC (TURBO)
JTA COLETOR ADMISSÃO



40226 B
40226 CB



40121 PAK
40121 CC (TURBO)



40222 PAK



40242 NA
JTA TAMPA



40243 NA
JTA VÁLVULA



40147 NA
JTA DO LADO
DO VOLANTE



40235 NA
JTA BOMBA



40125 NA
JTA BBA DÁGUA A

JG JTA RETIFICAÇÃO



40130 NA
JTA CORPO



40246 NA
JTA BOMBA



40139 NA
JTA BLOCO (LADO
DO VOLANTE)



40128 NA
JTA BOMBA ÓLEO



40232 NA
JTA BOMBA
DÁGUA



40247 NA
JTA RESPIRO DO ÓLEO



40257 NA
JTA BBA



40123 NA
JTA TUBO



40249 NA
JTA TUBO
ÓLEO



40127 NA
JTA LATERAL DO



40537 NA
JTA CORPO



40230 NA
JTA BBA
DÁGUA/RADIADOR



40244 NA
JTA VÁLV.
ANTIPOLUIÇÃO



40231 NA
JTA
LUBRIFICAÇÃO



40236 NA
JTA TAMPA
COMANDO



40237 NA
JTA TAMPA
COMANDO



40216 CB
JTA CARTER

40206-KP

KIT PARAFUSOS DO CABEÇOTE

40206-KTRT

KIT DE RETENORES DO MOTOR

RET VALVULAS-08X11X10



1222509

RET CMD-30X52X07/30X44X07
(30x52x7) (30x44x7)



1142006 - 1150021

RET GIRABREQUIM DIANT-
30X43X10



1145074

RET GIRABREQUIM TRASEIRO-
70X90X10



1145075

2.0 16V 4C - TIPO/TEMPRA 92/99 - DOHC - GAS

40207-JGCB JG JTA MTR S/ CAB

40207-JGRS JG RETIF MTR S/ CAB

40207-JGSC JG JTA MTR C/ CAB DE FIBRA

40207-JGRV JG RETIF MTR C/ CAB DE FIBRA

40207-JRSC JG JTA MTR C/ CAB DE FIBRA E C/ RET

40207-JRRV JG RETIF MTR C/ CAB DE FIBRA E RET

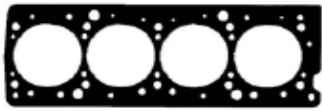

40201 SC - 1,9 MM - CIL. 85 MM
40201 KT - 2,9 MM - CIL. 85 MM
40201 TB - 2,4 MM - CIL. 85 MM

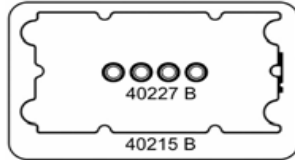

40227 B
40215 B
40240 KTBO
KIT JTA TAMPA VÁLVULAS



40141 PAK
40141 CC
JTA COLETOR ESCAPE



40151 BQ
BAQUELITE ADMISSÃO



40152 NA
JUNTA DA ADMISSÃO



40222 PAK
JTA SAÍDA
ESCAPE



40452 NA
JTA INJEÇÃO
ELETTRÔNICA



40248 NA
JTA COL
ADMISSÃO



40242 NA
JTA TAMPA
COMANDO AUXILIAR



40147 NA
JTA DO LADO
DO VOLANTE



40235 NA
JTA BOMBA DÁGUA



40125 NA
JTA BBA DÁGUA A
VÁLVULAS

JG JTA RETIFICAÇÃO



40130 NA
JTA CORPO



40246 NA
JTA BOMBA
DÁGUA



40241 NA
JTA BBA DÁGUA AO
BLOCO



40128 NA
JTA BOMBA ÓLEO



40232 NA
JTA BOMBA
DÁGUA



40135 PAK
JTA CÂMARA BOMBA
DE ÓLEO



40257 NA
JTA BBA



40123 NA
JTA TUBO



40249 NA
JTA TUBO
ÓLEO



40127 NA
JTA LATERAL DO



40537 NA
JTA CORPO



40230 NA
JTA BBA
DÁGUA/RADIADOR



40244 NA
JTA VÁLV.
ANTIPOLUIÇÃO



40231 NA
JTA
LUBRIFICAÇÃO



40236 NA
JTA TAMPA
COMANDO



40237 NA
JTA TAMPA
COMANDO



40216 CB

40207-KP

KIT PARAFUSOS DO CABEÇOTE

40207-KTRT

KIT DE RETENORES DO MOTOR

RET VALVULAS-07X10X10



1222509

RET CMD-30X52X07/30X44X07



1142006 - 1150021

RET GIRABREQUIM DIANT-
30X43X10



1145074











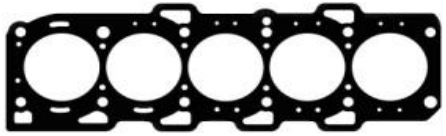

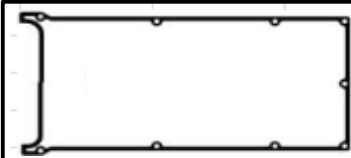
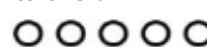



RET GIRABREQUIM TRASEIRO-
70X90X10

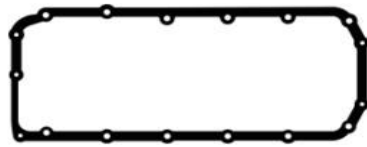

1145075

2.0 20V 5C - MAREA / BRAVA : 96/00 - MTR 182A1

40402-JGCB	JG JTA MTR S/ CAB	40402-JGRS	JG RETIF MTR S/ CAB
40402-JGSC	JG JTA MTR C/ CAB DE FIBRA	40402-JGRV	JG RETIF MTR C/ CAB DE FIBRA
40402-JGML	JG JTA MTR C/ CAB DE CHAPA	40402-JGRM	JG RETIF MTR C/ CAB DE CHAPA
40402-JRSC	JG JTA MTR C/ CAB DE FIBRA E C/ RET	40402-JRRV	JG RETIF MTR C/ CAB DE FIBRA E RET
40402-JRML	JG JTA MTR C/ CAB DE CHAPA E C/ RET	40402-JRRM	JG RETIF MTR C/ CAB DE CHAPA E RET

 <p>40902 SC - 1,9 MM - CIL. 84 MM 40902 MLS - 1,9 MM - CIL. 84 MM 40902 MLS-3M - 2,9 MM - CIL. 84 MM 40902 KT - 2,9 MM - CIL. 84 MM JTA CABEÇOTE</p>  <p>40924 SC JTA ADMISSÃO</p>	 <p>40926 BO - JTA TAMPA VÁLVULAS</p>  <p>40941BO - VEDADOR DAS VELAS T V</p> <p>40926 KTBO - KIT JTAS TAMPA VÁLVULAS</p>  <p>40920 PAK JTA ESCAPE</p>	 <p>40921 F JTA COLETOR ESCAPE</p>  <p>40452 NA JTA INJEÇÃO</p>  <p>40935 NA JTA CANO DÁGUA</p> <p>JG JTA RETIFICAÇÃO</p>
 <p>40975 NA JTA DISTRIBUIÇÃO/ BBA ÓLEIO</p>  <p>40929 NA JTA MANCAL</p>  <p>40402-KTBO KIT VEDADORES</p>  <p>261824 ANEL BUJÃO CARTER 18,2X24X1,5mm</p>	 <p>40931 NA JTA BOMBA DÁGUA</p>  <p>40716 CB JTA CARTER</p> <p>JG JTA RETIFICAÇÃO</p>	
<p>40402-KP KIT PARAFUSOS DO CABEÇOTE</p>	<p>40402-KTRT OU 40402 KTRT-F (com ret flange tras.) KIT DE RETENORES DO MOTOR</p> <p>RET VALVULAS-07X10X10</p>  <p>1213044</p> <p>RET VIRABREQUIM DIANT</p>  <p>31X47X07</p> <p>1140057</p> <p>RET CMD-55X68X08/30X42X07</p>  <p>1140157 - 1145093</p> <p>FLANGE TRASEIRA</p>  <p>40402 FR</p>	

2.3 16V 4C - FIAT / IVECO - DUCATO JTD MULTIJET/ DAILY : 06/ - MTR F1AEO481C/D/N - DIESEL

2.3 16V 4C - PEUGEOT - BOXER 06/ - MTR F1AEO481C/D/N - DIESEL

2.3 16V 4C - CITROEN - CITROEN: JUMPER 06/ - MTR F1AEO481C/D/N - DIESEL

51107-JGCB	JG JTA MTR S/ CAB	51107-JGRS	JG RETIF MTR S/ CAB
51107-JGSC	JG JTA MTR C/ CAB DE FIBRA	51107-JGRV	JG RETIF MTR C/ CAB DE FIBRA
51107-JGML	JG JTA MTR C/ CAB DE CHAPA	51107-JGRM	JG RETIF MTR C/ CAB DE CHAPA
51107-JRSC	JG JTA MTR C/ CAB DE FIBRA E C/ RET	51107-JRRV	JG RETIF MTR C/ CAB DE FIBRA E RET
51107-JRML	JG JTA MTR C/ CAB DE CHAPA E C/ RET	51107-JRRM	JG RETIF MTR C/ CAB DE CHAPA E RET



51103 MLS-1M - 1,1 MM
51103 MLS-2M - 1,2 MM
51103 MLS-3M - 1,3 MM
51103 SC-3M - 1,3 MM
JTA CABEÇOTE

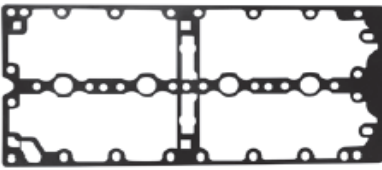

51226 MLS
JTA TAMPÁ VÁLVULAS



51161 PAK/F



51120 CV/NA
JTA ADMISSÃO



51117 BO
JTA SEMI-CARTER

51132 BO

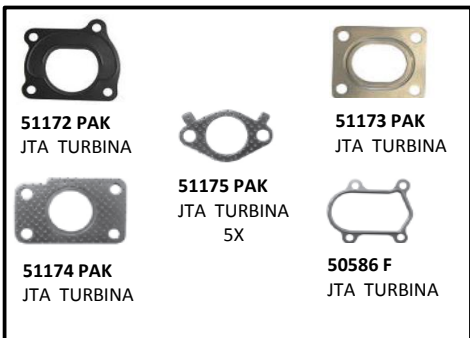

51172 PAK
JTA TURBINA

51173 PAK
JTA TURBINA

51174 PAK
JTA TURBINA

51175 PAK
JTA TURBINA 5X

50586 F
JTA TURBINA

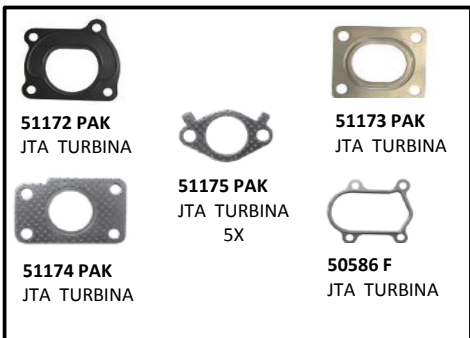

50496 CV
KIT JTA TURBINA

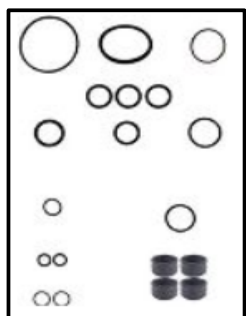

51107 KTBO



51166 NA
JTA CANO ÓLEO

JG JTA RETIFICAÇÃO



51107 KTAR



51143 NA
JTA DISTRIBUIÇÃO



51144 NA
JTA BBA OLEO



51115 BO
JTA CARTER

XXXXX-KP
KIT PARAFUSOS DO CABEÇOTE

51107-KTRT
KIT DE RETENORES DO MOTOR

RET VALV-5,5X10,5X19,5
1250193

RET COMANDO-34X60X10
1150193

RET VIRABREQUIM DIANT
50X80X14
1151193

RET VIRABREQUIM TRAS
83X113X13
1152193

2.4 16V 4C - FIAT - FREEMONT - MTR ED3 VVT

2.4 16V 4C - DODGE - JOURNEY - MTR ED3 VVT

2.4 16V 4C - JEEP - COMPASS - MTR ED3 VVT

41206-JGCB	JG JTA MTR S/ CAB	41206-JGRS	JG RETIF MTR S/ CAB
41206-JGSC	JG JTA MTR C/ CAB DE FIBRA	41206-JGRV	JG RETIF MTR C/ CAB DE FIBRA
41206-JGML	JG JTA MTR C/ CAB DE CHAPA	41206-JGRM	JG RETIF MTR C/ CAB DE CHAPA
41206-JRSC	JG JTA MTR C/ CAB DE FIBRA E C/ RET	41206-JRRV	JG RETIF MTR C/ CAB DE FIBRA E RET
41206-JRML	JG JTA MTR C/ CAB DE CHAPA E C/ RET	41206-JRRM	JG RETIF MTR C/ CAB DE CHAPA E RET



41201 MLS - 0,7 MM - CIL. 89 MM
41201 SC - 1,2 MM - CIL. 89 MM

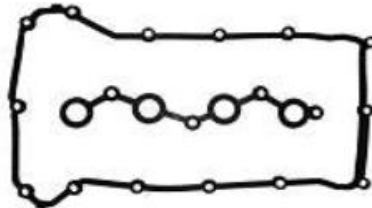

41226 KTBO



41221 PAK / F
JTA COLETOR ESCAPE



41220 BO



36607 KTBO
KIT DE BORRACHAS DO MOTOR

JG JTA RETIFICAÇÃO

41237 NA
JTA BBA OLEO



41232 NA

XXXXX-KP
KIT PARAFUSOS DO CABEÇOTE

41206-KTRT
KIT DE RETENORES DO MOTOR

RET VALV-4,5X10,8X19,8

125008001

RET VALV-42X55X07

115018001

RET TRAS-85X103X08

1151194

2.4 20V 5C - MAREA 01 /

40908-JGCB	JG JTA MTR S/ CAB	40908-JGRS	JG RETIF MTR S/ CAB
40908-JGSC	JG JTA MTR C/ CAB DE FIBRA	40908-JGRV	JG RETIF MTR C/ CAB DE FIBRA
40908-JGML	JG JTA MTR C/ CAB DE CHAPA	40908-JGRM	JG RETIF MTR C/ CAB DE CHAPA
40908-JRSC	JG JTA MTR C/ CAB DE FIBRA E C/ RET	40908-JRRV	JG RETIF MTR C/ CAB DE FIBRA E RET
40908-JRML	JG JTA MTR C/ CAB DE CHAPA E C/ RET	40908-JRRM	JG RETIF MTR C/ CAB DE CHAPA E RET



40902 SC - 1,9 MM - CIL. 84 MM
 40902 MLS - 1,9 MM - CIL. 84 MM
 40902 MLS-3M - 2,9 MM - CIL. 84 MM
 40902 KT - 2,9 MM - CIL. 84 MM
 JTA CABEÇOTE

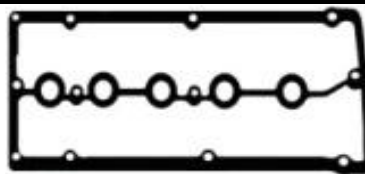

40927 BO
 KIT TAMPA VÁLVULAS



40921 F
 JTA DA TUBAGEM ESCAPE



40924 SC
 JTA ADMISSÃO



40920 PAK
 JTA ESCAPE



40935 NA
 JTA CANO DÁGUA



10452 NA
 JTA INJEÇÃO

JG JTA RETIFICAÇÃO



40975 NA
 JTA DISTRIBUIÇÃO / BBA



40929 NA
 JTA DO MANCAL TRASEIRO



40931 NA
 JTA BOMBA DÁGUA



40402-KTBO
 KIT VEDADORES MOTOR



261824
 ANEL BUJÃO CARTER
 18,2X24X1,5mm



40716 CB
 JTA CARTER

40402-KP KIT PARAFUSOS DO CABEÇOTE

40402-KTRT 40402 KTRT-F (com ret flange tras.) KIT DE RETENORES DO MOTOR

RET VALVULAS-07X10X10



1213044

RET CMD-55X68X08/30X42X07



1140157



1145093

RET VIRABREQUIM DIANT

31X47X07



1140057

FLANGE TRASEIRA



40402 FR

2.5/2.8 8V 4C - FIAT - DUCATO 94/ - ASP / TURBO : INJ. INDIRETA

2.5/2.8 8V 4C - IVECO - DAILY 94/ - ASP / TURBO : INJ. INDIRETA

2.5/2.8 8V 4C - CITROEN - JUMPER 94/ - ASP / TURBO : INJ. INDIRETA

2.5/2.8 8V 4C - PEUGEOT - BOXER 94/ - ASP / TURBO : INJ. INDIRETA

51006-JGCB	JG JTA MTR S/ CAB	51006-JGRS	JG RETIF MTR S/ CAB
51006-JGSC	JG JTA MTR C/ CAB DE FIBRA	51006-JGRV	JG RETIF MTR C/ CAB DE FIBRA
51006-JRSC	JG JTA MTR C/ CAB DE FIBRA E C/ RET	51006-JRRV	JG RETIF MTR C/ CAB DE FIBRA E RET

51001 SC-1M - 1,6 MM
51001 SC-1M - 1,7 MM
51001 SC-1M - 1,8 MM

51026 BO
JTA TAMPA VÁLVULAS

51021 PAK/F
JTA COLETOR ESCAPE

51019 PAK
JTA ADMISSÃO

50583 PAK

50582 F

50540 NA

51550 NA

50549 NA
JTA TERMOSTATO

51038 NA
JTA TUBO AGUA

50573 F

51006 KTBO-SUP
VEDADOR SUPERIOR

160812

161418

51018 NA
JTA ADMISSÃO

51037 PAK
JTA CANO ÓLEO

51022 FF

JG JTA RETIFICAÇÃO

50553 NA
JTA

51033 NA
JTA

50555 NA
JTA

51024 PAK

50547 NA
JTA BBA INJETORA

50042 NA
JTA

51034 NA
JTA FILTRO ÓLEO

50550 NA
JTA BBA INJ

50532 NA
JTA CANO D AGUA

50551 NA
JTA MANCAL

50552 NA
JTA

51006 KTAR





51006 KTBO

51017 BO-A
CARTER BORRACHA- A

51017 BO-B
CARTER BORRACHA- B

51017 CBLT

51018 CBLT
JTA CARTER

<p>51105-KP KIT PARAFUSOS DO CABEÇOTE</p>	<p>51106-KTRT 51106 KTRT-F (com ret flange tras.) KIT DE RETENTORES DO MOTOR</p>
	<p>RET VALVULAS-08X12X11 R CMD-55X70X08/51X70X11</p>
	 
	<p>1222396 1150040 - 1150140</p>
	<p>FLANGE GIRABREQUIM TRASEIRO RET GIRABREQUIM TRASEIRO- 70X90X10</p>
	 
	<p>51106 FR (TRASEIRO) 51105 FR (DIANTEIRO)</p>

2.5/2.8 8V 4C - FIAT / IVECO - DUCATO / DAILY : 96/02 - ASP / TURBO: INJ. DIRETA

2.5/2.8 8V 4C - CITROEN / PEUGEOT - JUMPER / BOXER : 96/02 - ASP / TURBO: INJ. DIRETA

51106-JGCB	JG JTA MTR S/ CAB	51106-JGRS	JG RETIF MTR S/ CAB
51106-JGSC	JG JTA MTR C/ CAB DE FIBRA	51106-JGRV	JG RETIF MTR C/ CAB DE FIBRA
51106-JGML	JG JTA MTR C/ CAB DE CHAPA	51106-JGRM	JG RETIF MTR C/ CAB DE CHAPA
51106-JRSC	JG JTA MTR C/ CAB DE FIBRA E C/ RET	51106-JRRV	JG RETIF MTR C/ CAB DE FIBRA E RET
51106-JRML	JG JTA MTR C/ CAB DE CHAPA E C/ RET	51106-JRRM	JG RETIF MTR C/ CAB DE CHAPA E RET

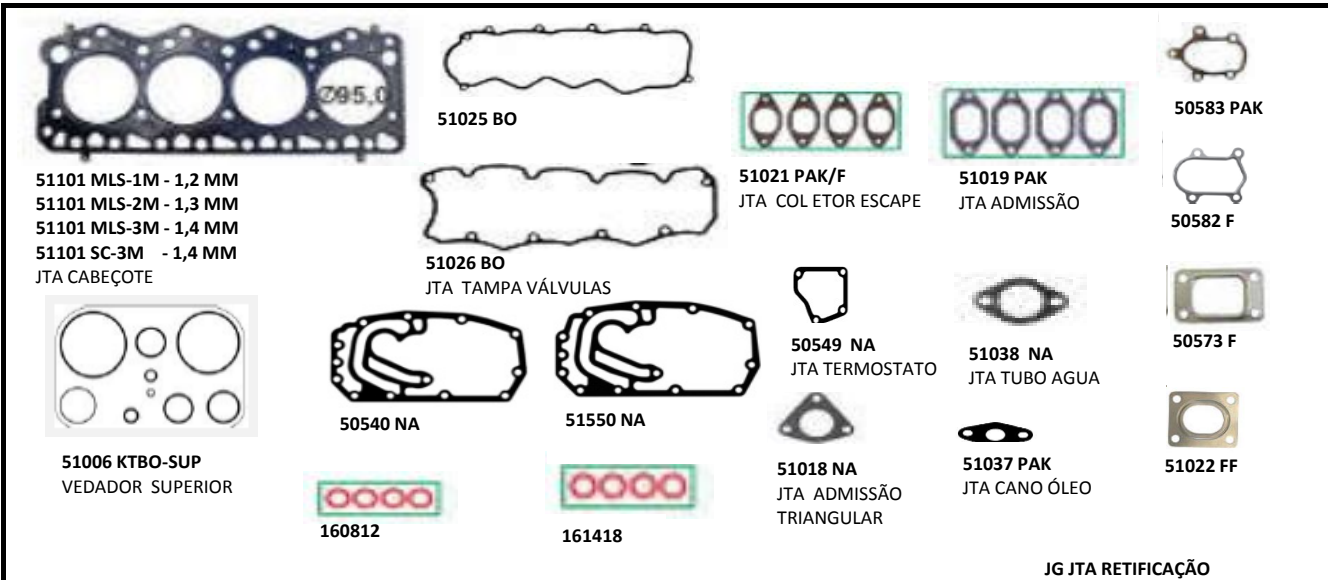

51101 MLS-1M - 1,2 MM
51101 MLS-2M - 1,3 MM
51101 MLS-3M - 1,4 MM
51101 SC-3M - 1,4 MM
JTA CABEÇOTE

51025 BO
51026 BO
JTA TAMPA VÁLVULAS

51021 PAK/F
JTA COL ETOR ESCAPE

51019 PAK
JTA ADMISSÃO

50583 PAK
50582 F
50573 F
51022 FF

50549 NA
JTA TERMOSTATO

51038 NA
JTA TUBO AGUA

51018 NA
JTA ADMISSÃO TRIANGULAR

51037 PAK
JTA CANO ÓLEO

51006 KTBO-SUP
VEDADOR SUPERIOR

160812
161418

JG JTA RETIFICAÇÃO

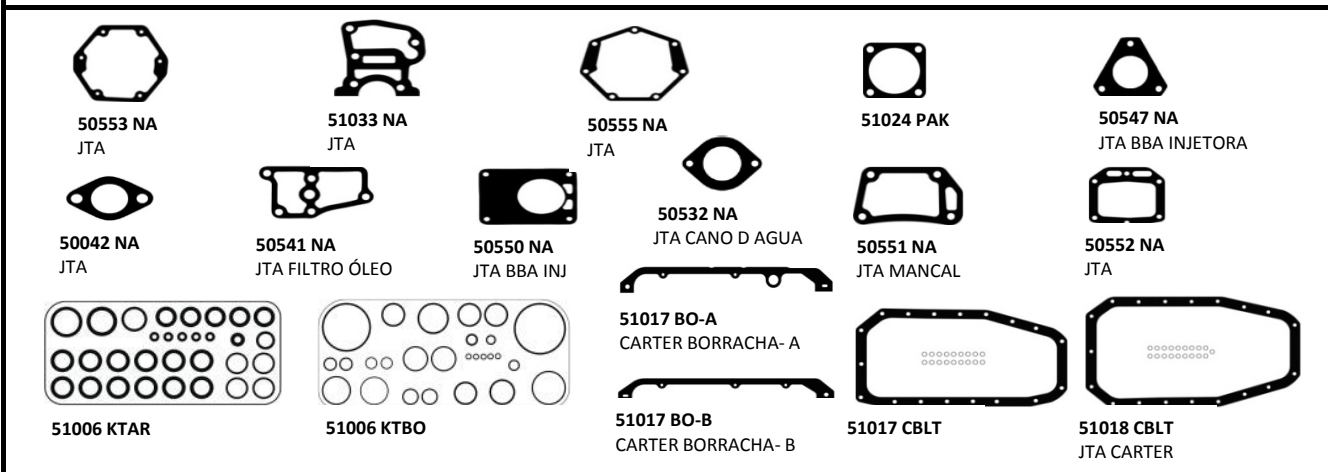

50553 NA
JTA

51033 NA
JTA

50555 NA
JTA

51024 PAK

50547 NA
JTA BBA INJETORA

50042 NA
JTA

50541 NA
JTA FILTRO ÓLEO

50550 NA
JTA BBA INJ

50532 NA
JTA CANO D AGUA

50551 NA
JTA MANCAL

50552 NA
JTA

51017 BO-A
CARTER BORRACHA- A

51017 BO-B
CARTER BORRACHA- B

51017 CBLT

51018 CBLT
JTA CARTER

51006 KTAR

51006 KTBO

51105-KP
KIT PARAFUSOS DO CABEÇOTE

51106-KTRT **51106 KTRT-F (com ret flange tras.)**
KIT DE RETENORES DO MOTOR

RET VALVULAS-08X12X11 R CMD-55X70X08/51X70X11



1222396 1150040 - 1150140

FLANGE GIRABREQUIM TRASEIRO RET GIRABREQUIM TRASEIRO- 70X90X10





51106 FR (TRASEIRO) 51105 FR (DIANTEIRO)

3.0 16V 4C - FIAT - DUCATO 08/ HDI - MTR F30DT

3.0 16V 4C - IVECO - DAILY 08/ HDI - MTR F30DT

3.0 16V 4C - CITROEN - JUMPER 08/ HDI - MTR F30DT

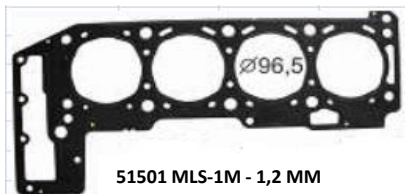
51506-JGCB	JG JTA MTR S/ CAB	51506-JGRS	JG RETIF MTR S/ CAB
51506-JGSC	JG JTA MTR C/ CAB DE FIBRA	51506-JGRV	JG RETIF MTR C/ CAB DE FIBRA
51506-JGML	JG JTA MTR C/ CAB DE CHAPA	51506-JGRM	JG RETIF MTR C/ CAB DE CHAPA
51506-JRSC	JG JTA MTR C/ CAB DE FIBRA E C/ RET	51506-JRRV	JG RETIF MTR C/ CAB DE FIBRA E RET
51506-JRML	JG JTA MTR C/ CAB DE CHAPA E C/ RET	51506-JRRM	JG RETIF MTR C/ CAB DE CHAPA E RET



51501 MLS-1M - 1,2 MM
 51501 MLS-2M - 1,3 MM
 51501 MLS-3M - 1,4 MM
 51501 MLS-4M - 1,5 MM
 51501 MLS-5M - 1,6 MM
 51101 SC-3M - 1,4 MM

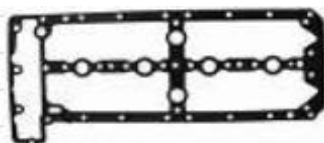

51526 MLS
 JTA TAMPA VÁLVULAS



51521 PAK/F
 JTA COLETOR ESCAPE



51520 NA
 JTA ADMISSÃO



51506 KTBO



51532 BO
 JTA TERMOSTATO



51572 PAK
 JTA



51573 PAK
 JTA

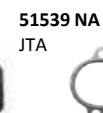

51539 NA
 JTA



50582 F



51522 F
 JTA ESCAPE



51166 NA
 JTA CANO ÓLEO

JG JTA RETIFICAÇÃO



51506 KTAR



51574 NA
 JTA



51544 NA
 JTA



51534 NA
 JTA



51543 NA - JTA



51530 NA
 JTA



51543 NA
 JTA

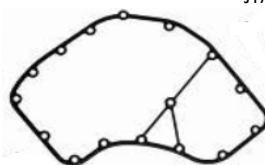

51528 NA
 JTA



51516 BO
 JTA CARTER

XXXXX-KP
 KIT PARAFUSOS DO CABEÇOTE

51506-KTRT
 KIT DE RETENORES DO MOTOR
 RET VÁLVULAS-5,5X10,5X19,5



RET VIRABREQUIM DIANT

RET VIRABREQUIM TRAS

50X70X11











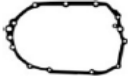

90X120X13

























































115114001

115214001



































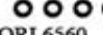











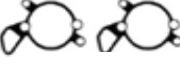















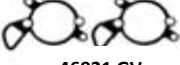

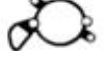

CÂMBIOS

							
40281 PP	40282 PP	40283 PP	40381 PP	40382 PV	40383 PV	40387 PV	40388 PV
40280 PP Jogo para câmbio – Fiat Tempra 92 A 99 / Pálio 1.6 - 16V 96 em diante			40391 PV Jogo para câmbio – Spazio / Panorama / Uno / Prêmio / Oggi / Elba 5 marchas (todos)				
							
40681 NA	40682 NA	40683 NA	ORI 039	ORI 154			
40680 NA Jogo para câmbio – Brava 1.6 / Doblo 1.3							



















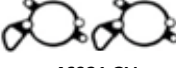













































CARBURADORES

								
40351 GV	40352 GV	40357 NA	AAC 012	ORI 008	ORI 012	40353 BQ		
40350 GV Jogo para carburador - Fiat 147 / Fiorino / Panorama - sem baquelite								
40350 GV-BQ Jogo para carburador – Fiat 147 / Fiorino / Panorama - com baquelite								
								
10957 GV	40363 NA	40365 GV	AAF 010	ORI 005	ORI 008	ORI 009	ORI 011	
40360 GV Jogo para carburador Weber duplo – Prêmio / Elba / Uno 1500 (todos)								
								
10957 GV	40335 NA	40358 GV	40359 GV	AAA 007	ORI 005	ORI 008	ORI 009	40367 BQ
40370 GV Jogo para carburador Weber duplo – Prêmio / Elba / Uno 1500 (todos) sem baquelite								
40370 GV-BQ Jogo para carburador Weber duplo – Prêmio / Elba / Uno 1500 (todos) com baquelite								
								
40663 NA	40665 GV	40666 GV	40667 GV	AAC 007/A	AAC 008/D			
								
AAF 005	ORI 006	ORI 008	ORI 009	ORI 011	ORI 012			
40660 GV Jogo para carburador Weber duplo - Tempra / Uno / Mille Brio								
								
10831 NA	10847 NA	10848 GV	10853 NA	10859 NA	AAA 005	AAA 010	ORI 004	ORI 006
40850 GV Jogo para carburador Solex simples – Prêmio / Uno / Elba 1500 – álcool								
								
40893 AB	46891 NA	46892 GV	46894 NA	46895 GV	AAA 006/D	AAA 008/B	ORI 006	ORI 009
40890 GV Jogo para carburador Weber duplo TLDF – Fiat / Chevrolet / VW / Ford								









JOGOS DE JUNTAS E REPAROS PARA INJEÇÃO ELETRÔNICA

										
10452 NA	11071 NA	40043 NA	40075 NA	ORI 009	ORI 012	ORI 203				
40030 NA	Jogo para I.E – Tempra 2.0 16Válvulas - MPI 95 ed – sistema Magnetti Marelli									
										
10452 NA	11071 NA	11095	40043 NA	40075 NA	ORI 009	ORI 012	ORI 203			
SCKIT 40030	Reparo para I.E – Tempra 2.0 16V MPI 95 ed – sistema Magnetti Marelli									
										
40422 NA	40049 NA	ORI 009	ORI 012	ORI 014	ORI 107	ORI 203	ORI 2116	ORI 2117	ORI 6560	
40040 NA	Jogo para I.E - Pálio 1.0 / 1.5 8 válvulas MPI – sistema Magnetti Marelli									
										
11095	40422 NA	40049 NA	ORI 009	ORI 012	ORI 014	ORI 107	ORI 203	ORI 2116	ORI 2117	ORI 6560
SCKIT 40040	Jogo para I.E - Pálio 1.0 / 1.5 8válvulas MPI – sistema Magnetti Marelli									
										
46921 GV	40053 NA	40063 NA	40072 NA	ORI 014	ORI 019	ORI 2116	46921 BO			
40050 NA	Jogo para I.E – Tempra 2.0 – sistema Magnetti Marelli - SPT – s/ baquelite									
40050 NA-BQ	Jogo para I.E – Tempra 2.0 – sistema Magnetti Marelli - SPT – c/ baquelite									
										
11066	11084	40053 NA	40063 NA	40072 NA	ORI 014	ORI 019	ORI 2116	46921 BO		
SCKIT 40050	Reparo para I.E – Tempra 2.0 – Sistema Magnetti Marelli SPT – c/ baquelite									
										
46921 GV	40052 NA	40063 NA	40072 NA	ORI 014	ORI 019	ORI 2116	46921 BO			
40060 NA	Jogo para I.E - Uno / Prêmio 1.5 / 1.6 – sistema Magnetti Marelli – s/ baquelite									
40060 NA-BQ	Jogo para I.E - Uno / Prêmio 1.5 / 1.6 – sistema Magnetti Marelli – c/ baquelite									
										
11066	11084	40073 NA	40074 NA	ORI 014	ORI 019	ORI 2116	46921 BQ			
SCKIT 40070	Reparo para I.E – Siena / Pálio 16válvulas – Sistema Magnetti Marelli c/ baquelite									









JOGOS DE JUNTAS E REPAROS PARA INJEÇÃO ELETRÔNICA

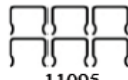



								
40081 NA	40082 NA	40723 GV	ORI 107	ORI 2109	ORI 2116	ORI 2117	40723 BO	
40080 NA	Jogo para I.E – Fiat Tipo 1.6 – Motronic s/ baquelite							
40080 NA-BQ	Jogo para I.E – Fiat Tipo 1.6 – Motronic c/ baquelite							
								
46921 GV	40053 NA	40072 NA	40092 NA	ORI 014	ORI 019	ORI 2116	46921 BO	
40090 NA	Jogo para I.E – Tempra 2.0-single point – sistema Magnetti Marelli – s/ baquelite							
40090 NA-BQ	Jogo para I.E – Tempra 2.0-single point – sistema Magnetti Marelli – c/ baquelite							
								
11066	11084	40072 NA	40092 NA	ORI 014	ORI 019	ORI 2116	40072 NA	
SCKIT 40090	Reparo para I.E – Tempra 2.0 – single point – sistema Magnetti Marelli – c/ baquelite							
								
10452 NA	40043 NA	40102 NA	40241 NA	ORI 009	ORI 012	ORI 203	ORI 2116	
40100 NA	Jogo para I.E – Tempra 2.0 16 válvulas – sistema Magnetti Marelli							
								
10452 NA	11095	40043 NA	40102 NA	40241 NA	ORI 009	ORI 012	ORI 203	ORI 2116
SCKIT 40100	Reparo para I.E – Tempra 2.0 16 Válvulas – sistema Magnetti Marelli							
								
40111 NA	ORI 012	ORI 107	ORI 203	ORI 2116	ORING 6501			
40110 NA	Jogo para I.E – Pálio 1.6 16 Válvulas / Strada Weekend 1.6 98 ED - sistema Magnetti Marelli							
								
11095	40111 NA	ORI 012	ORI 107	ORI 203	ORI 2116	ORING 6501		
SCKIT 40110	Reparo para I.E – Pálio 1.6 16 Valvulas / Strada Weekend 1.6 98 ED – sistema Magnetti Marelli							
								
10412 NA	40131 NA	ORI 203						
40130 NA	Jogo para I.E - Marea Weekend 20 Válvulas, 5 cc – sistema Motronic 2.10.4 multi point Bosch							
								
11085	46921 GV	40053 NA	40063 NA	40072 NA	ORI 014	ORI 019	ORI 2116	
40140 NA	Jogo para I.E – Mille SX - sistema Magnetti Marelli							

JOGOS DE JUNTAS E REPAROS PARA INJEÇÃO ELETRÔNICA





 11066	 11085	 40053 NA	 40063 NA	
 40072 NA	 ORI 014	 ORI 019	 ORI 2116	 46921 BQ
SCKIT 40140 Reparo para I.E – Mille SX – sistema Magnetti Marelli – c/ baquelite				











 11095	 40112 NA	 ORI 010	 ORI 012	 ORI 203	 ORI 2116	 ORING 6501
SCKIT 40150 Reparo para I.E – Pálio 1.6 - 16 Válvulas – sistema Magnetti Marelli						





 10452 NA	 11095	 40043 NA	 40102 NA	
 40241 NA	 ORI 009	 ORI 012	 ORI 203	 ORI 2116
SCKIT 40160 Reparo para I.E. – Tempra 2.0 16Válvulas – sistema Magnetti Marelli				











 10452 NA	 11095	 40053 NA	 ORI 012	 ORI 107	 ORI 203	 ORI 2116
SCKIT 40170 Reparo para I.E – Tipo 1.6 nacional						

 40022 JGBQ	 40790-A-BO	 40718 BQ	 ORI 203
SCKIT 40190 Kit para I.E - Fire 8 válvulas			

































 40023 JGBQ	 40719 BQ	 40733 B	 ORI 203
SCKIT 40200 Kit para I.E – Fire 16 válvulas			

 40751 NA	 11095	 40733 B	 ORI 009	 ORI 012
 ORI 012 VITON	 ORI 107	 ORI 203	 ORI 2109	 ORI 2116
SCKIT 40580 Reparo para I.E. – Doblo / Siena / Strada				

 40161 NA	 11095	 ORI 009	 ORI 012	 ORI 203
SCKIT 40590 Jogo para I.E - Stilo / Meriva 1.8 16 válvulas				

 40790-A-BO	 11095	 ORI 009	 ORI 012	 ORI 012 VITON
 ORI 107	 ORI 203	 ORI 2109	 ORI 2116	 ORING 9094
SCKIT 40690 Reparo para I.E. – Pálio / Punto 1.4				















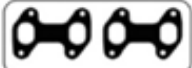

JOGOS DE JUNTAS E REPAROS PARA INJEÇÃO ELETRÔNICA

							
ORI 019	ORI 107	46760-A-BO	ORI 203	ORI 012	ORI 2109	ORI 012 VITON	ORI 2116
40760 B Jogo para I.E- Fiat Pálio ELX 1.0 -16 V. Fire 2001 / Siena EX 1.0-16 V. Fire 2001 / Pálio Weekend 1.0 - 16 V. Fire 2001 / Siena ELX 1.0-16V Fire 2001 / MPFI							
							
ORI 012	ORI 107	46760-A-BO	ORI 203	ORI 009	ORI 2109	ORI 012 VITON	ORI 2116
40770 B Jogo para I.E – Fire 1.3 16 V – Pálio / Pálio Weekend / Doblo ELX / Siena City 2000 e Siena ELX 2002							
							
46079 BO	ORI 107	11095	ORI 203	ORI 009	ORI 2109	ORI 012 VITON	ORI 2116
40780 B Jogo para I.E – Fire 1.6 16 V. (96-2000) / Pálio Weekend Sport Sti le 1.6-16V (97-2000) / Pálio Stile / Adventure ELX (2001) / Doblo 1.6-16V (2002)							
							
40790-A-BO	ORI 107	11095	ORI 203	ORI 009	ORI 2109	ORI 012 VITON	ORING 9094
40790 B Jogo para I.E – Fiat Pálio EX 1.0 8 V. / Fire 2001 / Pálio Young 1.0 8 V. / Fire 2001 MPFI.							

COLETOR / ADMISSÃO / ESCAPE / CATALIZADOR

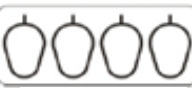
			
40037 PAK	40421 PAK	40337 PAK/F	40002 PAK
Junta do catalizador Fiat	Junta do coletor esc./ adm.) Pálio 1.0/1.5 (c/ anel fogo) - 46451539	Junta do escape - Pálio 1.0 / 1.5 96 ed - orig. 7798291	Junta do catalizador Fiat Pálio - orig. 46413166
			
40220 PAK	40721 PAK	40721 F	
Junta da admissão Tipo 2.0	Junta do escape Tempra / Tipo 16 V - 7722485	Junta do escape Tempra turbo - 50001414	
			
40003 PAK	40222 PAK/F	40321 PAK	40322 PAK/F
Junta do catalizador Tempra 2.0 16V. 93/94	Junta da saída do escape Tempra 2.0 8V - orig. 4176386	Jogo do coletor de adm. e escape Fiat 1300 / Mille (c/ anel de fogo) orig. 7732314	Junta da saída do escape Fiat 147













COLETOR / ADMISSÃO / ESCAPE / CATALIZADOR

			
40320 PAK	40420 PAK	40521 PAK	40522 PAK/F/FF
Jogo da tubagem admissão e escape Fiat 1500 - Fiasa (c/ anel de fogo)	Junta do coletor - Fiat 1300 / 1500 / 1600 (tds) - 85 ed orig. 7798291	Jogo da tubagem de adm. / escape Fiat 1500 - (c/ anel de fogo) orig. 4309031	Junta da saída do escape Fiat 1500 / Uno / Prêmio / Elba
			
40821 PAK	40621 PAK	40168 PAK/F	40041 BO
Junta do coletor escape Tipo 1.6 (c/ anel de fogo)	Jogo da tubagem adm. / escape Fiat 1.6 - (c/ anel de fogo)	Junta da saída do escape Pálio / Siena Fire 1.0 16V orig. 46737554	Borracha de admissão Pálio 16V 46402220
			
40024 PAK/F/FF	40622 PAK/F/FF	40277 PAK/F	40022 JGBO
Jogo do col. de escape Fire 8 V orig. 46546134X	Junta saída escape Pálio / Siena - mtr Fire 1.0 8V orig. 4674747	Junta do pé do turbo do Pálio (furo 53 mm)	Jogo do col. de admissão Pálio EX 1.0 8 V Fire 2001 / Pálio Young 1.0 8V Fire 2001 MPFI
			
40119 JGBO	40023 KTBO	40920 PAK/F	40824 PAK
Jogo de borrachas de admissão Fire 1.3 8V	Jogo do coletor de admissão Fire 1.0 16 V 2001 - Pálio / Siena / Weekend	Junta da saída de escape Marea 1.8 16 V orig. 46772217	Junta da saída de escape Marea 1.8 16 V orig. 7783718











GAXETA ESCAPE

	
40020 PAK	
Anel de escape - Fire / Mille / Fiorino / Elba / Prêmio 77.27.596	



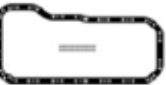

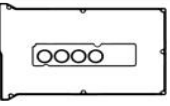

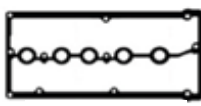

BAQUELITES

			
40151 BO	40353 BQ	40332 BQ	40367 BQ
Calço do coletor admissão Tempra 2.0 16V - 7668195	Calço carburador Solex simples Fiat 147	Calço carburador Fiat 147 - 4325461	Calço carburador Weber simples Fiat / Monza
			
46921 BO	10968 BO	SCBQ 2002	40723 BQ
Calço da injeção eletrônica	Calço do carburador mini progressivo - Uno	Flange da bomba de gasolina Fiat	Calço do corpo da borboleta Fiat Pálio
			
40361 BO	40562 BQ	40563 BQ	40362 BO
Calço do carburador Weber Fiat 1500 - 7507863	Bandeja do Uno eletrônico 77151530	Calço do carburador Uno	Calço do carburador Weber Fiat 1600 / Uno SX - 75135390









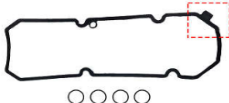

JUNTAS DE CARTER / JUNTAS DE TAMPA DE VÁLVULAS

			
40216 CB-LT	40217 CB	40816 CBLT	40326 CB-LT
Junta do cárter (c/ limitador) Tempra	Junta do cárter Tipo 2.0 8 válvulas	Junta do carter c/ limitador	Junta tampa de válvulas (c/ limitador) Fiat 147-1050/1300
			
40316 CBLT	40516 CB-LT	40616 CB-LT	40117 BO
Junta do cárter (c/ limitador) Uno/ Pálio 1.0 / 1.5 - 96 ed - 7669585	Junta do cárter (c/ limitador) mtr Fiat 1500 Argentino - 4179038	Junta do cárter (c/ limitador) Fiat 1600	Junta do Carter- Pálio motor Fire 1.0 8 V. (borracha)
			
40240 KTBO	40936 KTBO	40926 KTBO	40927 BO
Kit da tampa de válvulas Tempra 16 válvulas	Kit da tampa de válvulas Marca 1.8	Kit da tampa de válvulas Marea 20V até 2000	Kit da tampa de válvulas Marea 2.0 / 2.4 20V - 2001 ed

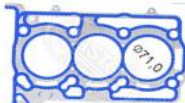
JUNTAS DIVERSAS

			
40044 BO	40431 BO	40114 BO	40244 CB
Vedador da bóia - Uno / Prêmio 5952089	Guarnição do termostato 4184495	Guarnição flange da bomba Fiat (todos) c/ inj.eletrônica - 7527545	Junta da bóia de tanque Fiat
			
40161 NA	OR1-220	40751 NA	10842 BO
Junta da injeção eletrônica Stilo 1.8 16 válvulas	Anel da Bobina Fire 14463980	Junta da injeção eletrônica Fire 1.0/1.3 16 válvulas	Guarnição válv. termostática Monza / Fiat (c/canaleta de encaixe) (901085515)

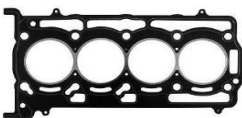
JUNTAS DIVERSAS

 <p>41001 SC</p>	 <p>41601 SC</p>	 <p>41140 KTBO</p>	 <p>41326 KTBO</p>
<p>JUNTA DO CABEÇOTE PALIO/TIPO TD 1.7 / 1.9 ESP: 1,65 MM - CIL. 83 MM</p>	<p>JUNTA DO CABEÇOTE PALIO/TIPO TD 1.7 / 1.9 ESP: 1,70 MM - CIL. 83 MM</p>	<p>KIT DE BORRACHAS DA BOMBA DE ÓLEO ETORQ 1.6/18 16V- EVO FLEX</p>	<p>JUNTA DA TAMPA DE VÁLVULAS PALIO/UNO/PUNTO/IDEA/500 1.0/1.4 8V EVO 09/KIT</p>
 <p>41326 BO</p>	 <p>41501 MLS</p>	 <p>41502 MLS</p>	 <p>41501 MLS</p>
<p>JUNTA DA TAMPA DE VÁLVULAS PALIO/UNO/PUNTO/IDEA/500 1.0/1.4 8V EVO 09/</p>	<p>JUNTA DO CABEÇOTE ARGO / CRONOS / MOBI / UNO 1.0 12V 3C 17/ FIREFLY - CHAPA</p>	<p>JUNTA DO CABEÇOTE ARGO / CRONOS / MOBI / UNO 1.3 16V 4C 17/ FIREFLY - CHAPA</p>	<p>JUNTA DO CABEÇOTE ARGO / CRONOS / MOBI / UNO 1.0 12V 3C 17/ FIREFLY - FIBRA</p>
 <p>41602MLS 1M - 0,95 MM 41602 MLS 2M - 1,05 MM 41602 MLS 3M - 1,15 MM</p>	 <p>41502 SC</p>	 <p>41526 BO</p>	
<p>JUNTA DO CABEÇOTE RENEGADE / COMPASS / TORO 2.0 16V TURBO DIESEL 4C 16/ MULTIJET - AT9</p>	<p>JUNTA DO CABEÇOTE ARGO / CRONOS / MOBI / UNO 1.3 16V 4C 17/ FIREFLY FIBRA</p>	<p>JUNTA DA TAMPA DE VÁLVULAS ARGO / CRONOS / MOBI / UNO 1.0 12V 3C 17/ FIREFLY</p>	